

Altitude au dessus de la mer
RPN = 373,60

Profil en long
Pente maximum
Rampe maximum

Situation des stations, bifurcations, plus longues voies d'évitement

Stations de block
d/p Renens

Distance de stat. à stat.
Kilométrage de la voie

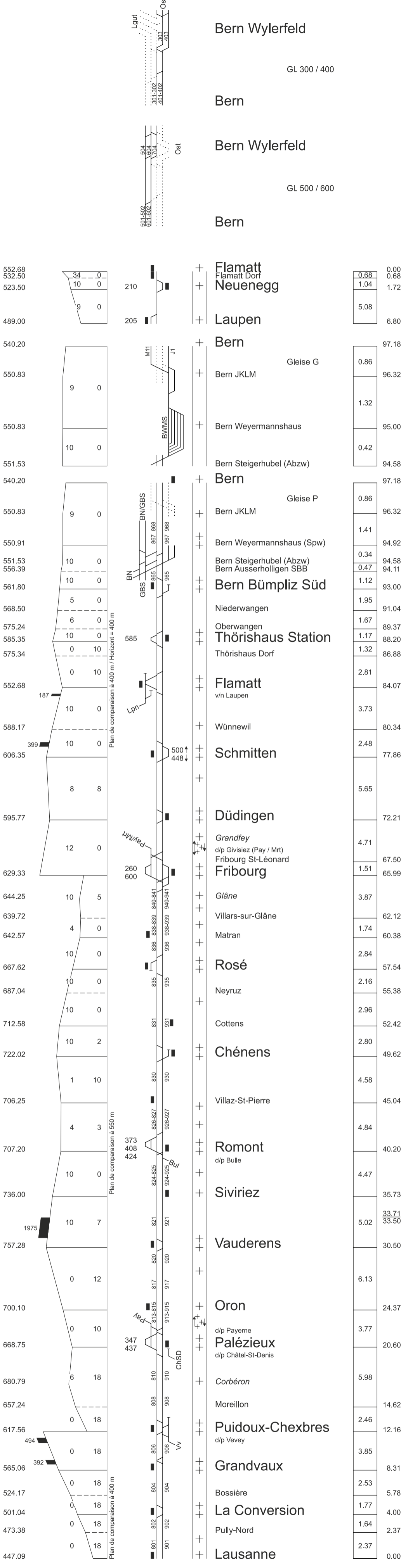

Altitude au dessus de la mer
RPN = 373.60

Profil en long

Pente maximum
Rampe maximum

Situation des stations, bifurcations, plus longues voies d'évitement

Stations de block

Distance de stat. à stat.
Kilométrage de la voie

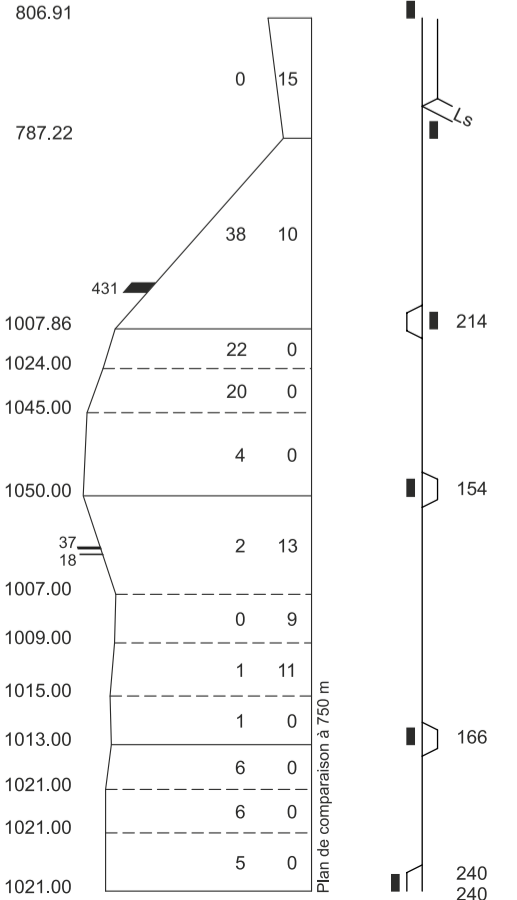

+	Vallorbe	46.31	0.00
+	Le Day	43.28	3.03
	d/p Lausanne		
+	Le Pont	11.63	11.28
	Charbonnières	0.91	12.19
+	Séchey	1.08	13.27
+	Le Lieu	2.19	15.45
		2.45	
+	Esserts-de-Rive	17.90	
	Le Rocheray	1.15	19.05
	Solliat-Golisse	1.44	20.50
+	Sentier-Orient	1.15	21.65
	Chez-le-Maitre-Ecoles	1.07	22.72
	Chez-le-Maitre	0.28	23.00
+	Le Brassus	1.40	24.40

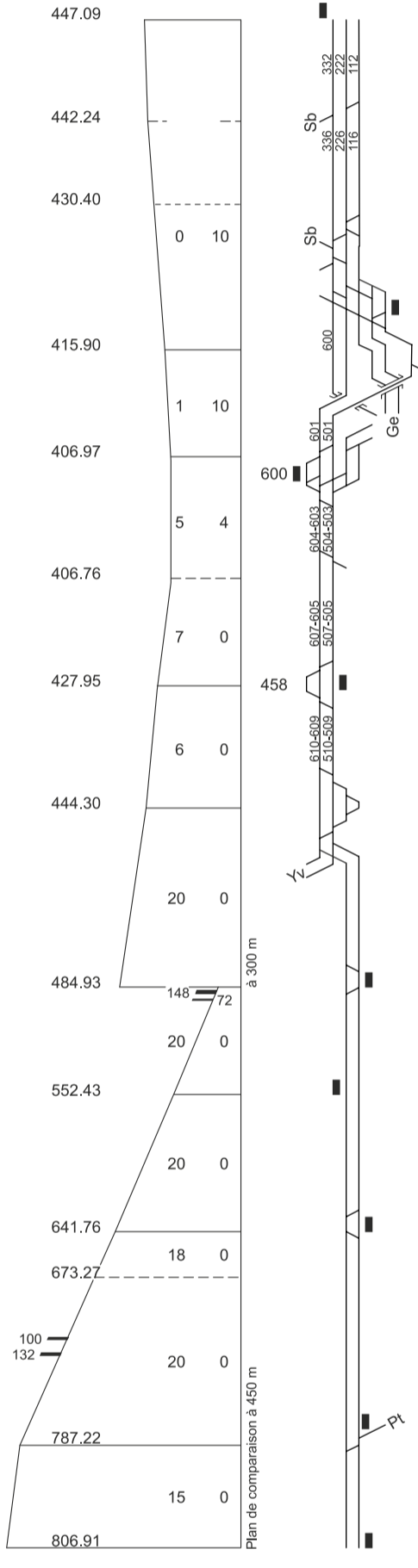

+	Lausanne		0.00
+	Lausanne (bif)	1.13	
+	Prilly-Malley	1.22	2.35
		1.40	
+	Renens VD Est (bif)	3.75	
+	Renens VD	0.76	4.51
	Renens VD Ouest (bif)	0.99	5.50
	d/p Genève (voies 201/101)		
+	Bussigny	1.43	6.93
	d/p Lausanne-Triage		
+	Fallien	4.05	
+	Vufflens-la-Ville	10.97	
+	Gollion	3.51	
+	Cossonay	14.49	
+	Vaux	3.92	
+	Dailens	18.41	
	d/p Yverdon-les-Bains		
		4.34	
+	La Sarraz	22.75	
+	Arnex	4.82	27.56
+	Croy-Romainmôtier	6.14	33.70
	Bretonnières	2.12	35.82
		7.46	
+	Le Day	43.28	
	d/p Le Brassus		
+	Vallorbe	3.03	46.31
	Vallorbe-Frontière		461.60

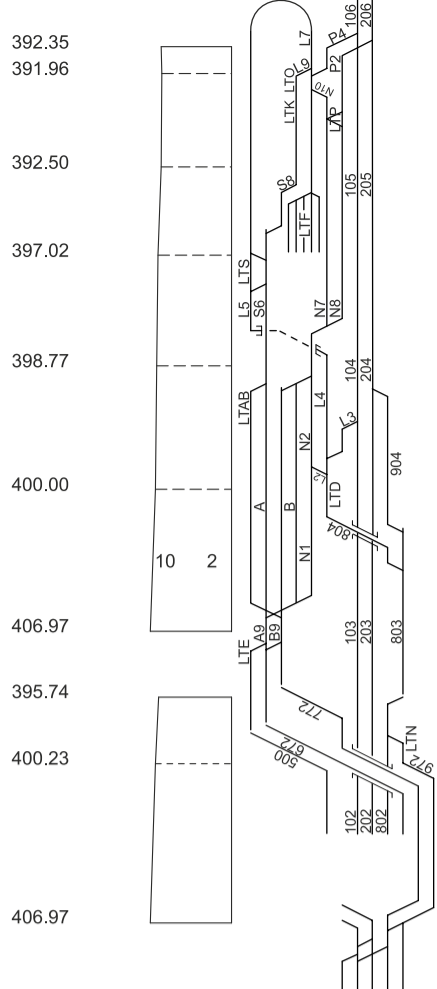

+	Lausanne-Triage F	9.30	
	Lausanne-Triage Ouest	0.51	9.81
	Record Buchet		
	Praz Lebaz	1.67	
+	Lausanne-Triage Sud	11.48	
	Bosse	1.37	
+	Lausanne-Triage D	12.85	
		0.36	
+	Lécheires (bif)	13.21	
		0.63	
	Lausanne-Triage Nord	13.84	
	voie 972	1.08	
+	Bussigny	14.92	
+	Lausanne-Triage A/B	8.10	
		0.98	
+	Lausanne-Triage E	7.12	13.39
	voie 772	1.53	
+	Bussigny	14.92	

d/p Vevey

d/p Palézieux

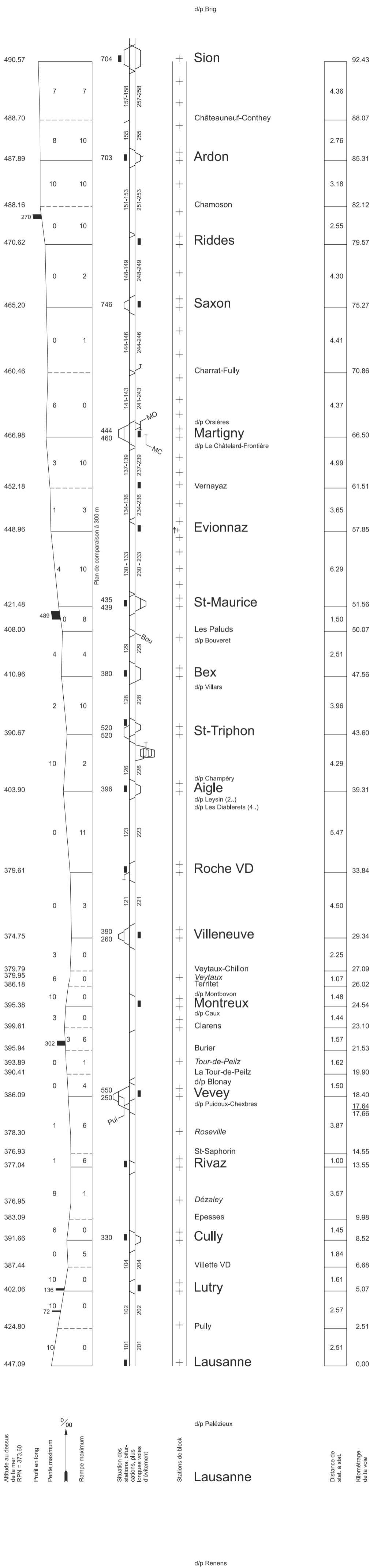

Altitude au dessus de la mer
RPN = 373.60

Profil en long
Pente maximum
Rampe maximum

Situation des stations, bifurcations, plus longues voies d'évitement

Stations de block

Distance de stat. à stat.

Kilométrage de la voie

d/p Brig

d/p Palézieux

d/p Renens

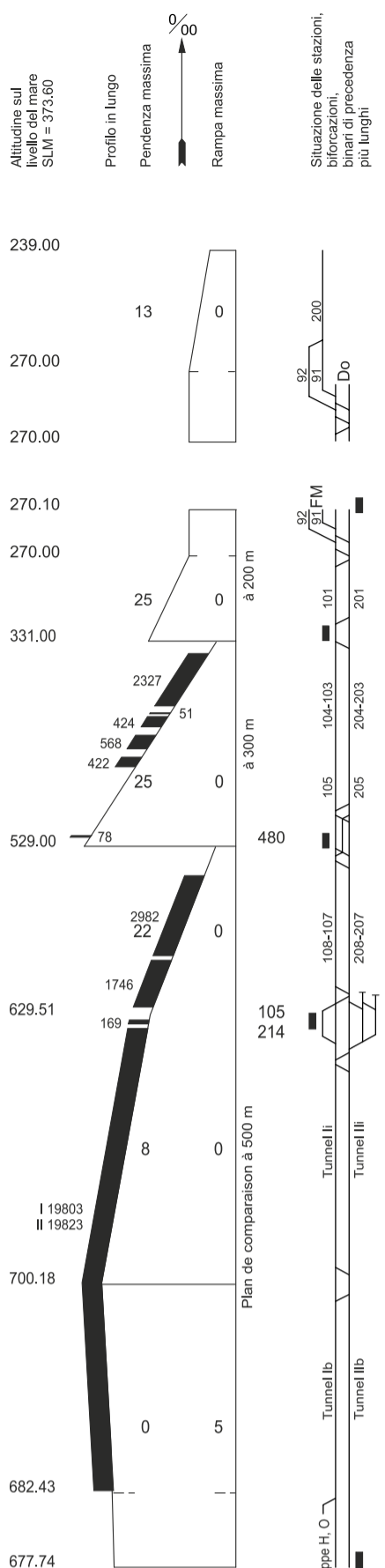
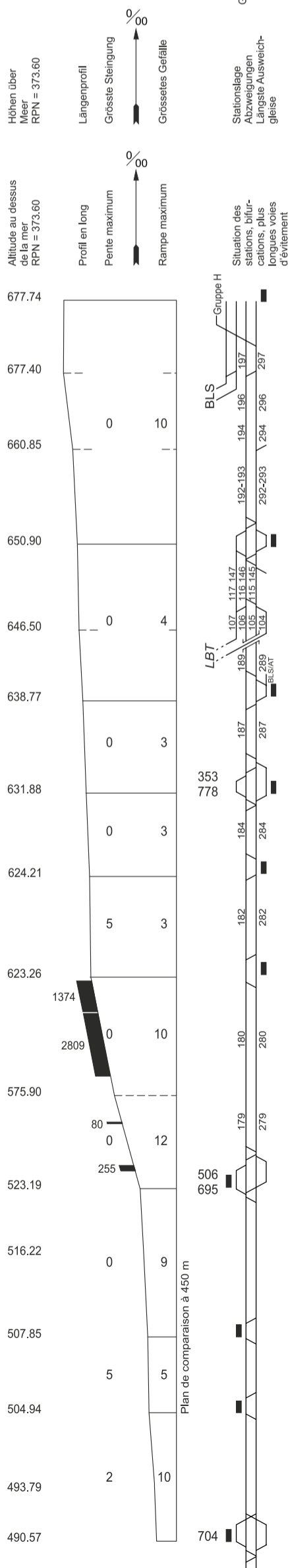

d/p St-Maurice

Sion

Clavoz

St-Léonard

Granges-Lens

Noës

Sierre/Siders

Salgesch

Leuk

Turtmann

Gampel-Steg

Raron

St. German (Abzw)

Visp

v/n Zermatt

Gamsen SBB

Gliser Grund

Brig Lötschberg (Abzw)

Brig

v/n Thun

Brig

v/n Zermatt

Brig (*Bahnhofplatz*)

v/n Furka

Brig

Staz. della Galleria Sempione

Brig Tunnel

Iselle di Trasquera

Galleria elicoidale

Varzo

Mognatta

Rio Rido

Preglia

Domodossola (bif)

Domodossola

Domodossola FM

Domodossola II

d/p Locarno

d/p Milano

92.43

5.72

3.40

101.56

6.57

108.13

4.12

112.25

5.33

117.58

118.83

122.11

125.86

125.87

130.09

133.28

50.06

147.15

145.55

145.55

147.15

149.55

156.35

167.48

167.48

18.80

11.13

9.20

1.60

1.24

1.24

1.24

2.59

2.59

5.23

5.23

6.31

1.24

1.24

1.24

1.24

1.24

1.24

1.24

1.24

1.24

1.24

1.24

1.24

1.24

1.24

1.24

1.24

1.24

1.24

1.24

1.24

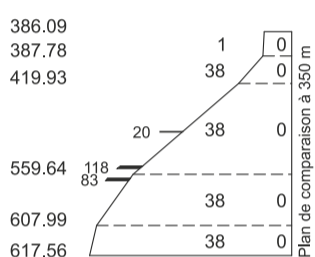
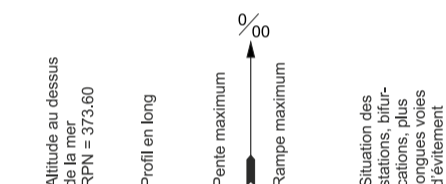

Stations de block

d/p Lausanne

Puidoux-Chexbres

Distance de stat. à stat.

Kilométrage de la voie

St-Maurice

Les Paluds
d/p Lausanne

Massongex

Monthey

Monthey Giovanola (embr)
Collombey

Monthey centre agr Bas-Valais (embr)
Monthey AGIP (embr)

Vionnaz

Vouvry

Les Evouettes

Bouveret

St-Gingolph (Suisse)

d/p Lausanne

Vevey

d/p Sion

Vevey

Vevey-Funi
Corseaux-Cornalles

Chexbres-Village

Puidoux-Chexbres

d/p Lausanne

Puidoux-Chexbres

d/p Palézieux

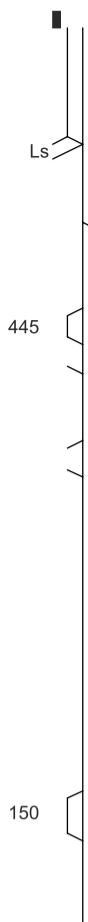
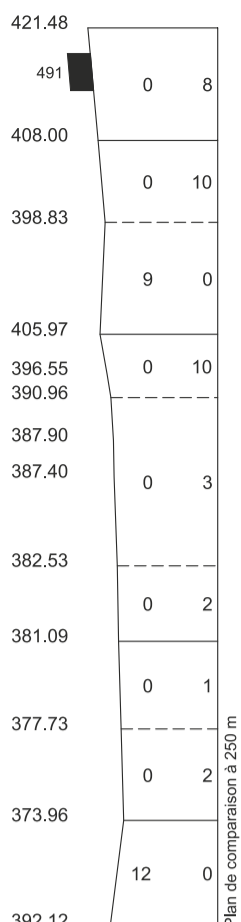

d/p Sion

St-Maurice

Les Paluds
d/p Lausanne

Massongex

Monthey

Monthey Giovanola (embr)
Collombey

Monthey centre agr Bas-Valais (embr)
Monthey AGIP (embr)

Vionnaz

Vouvry

Les Evouettes

Bouveret

St-Gingolph (Suisse)

d/p Lausanne

Vevey

d/p Sion

Vevey

Vevey-Funi
Corseaux-Cornalles

Chexbres-Village

Puidoux-Chexbres

Stations de block

d/p Lausanne

Puidoux-Chexbres

Distance de stat. à stat.

Kilométrage de la voie

St-Maurice

Les Paluds
d/p Lausanne

Massongex

Monthey

Monthey Giovanola (embr)
Collombey

Monthey centre agr Bas-Valais (embr)
Monthey AGIP (embr)

Vionnaz

Vouvry

Les Evouettes

Bouveret

St-Gingolph (Suisse)

d/p Lausanne

Vevey

d/p Sion

Vevey

Vevey-Funi
Corseaux-Cornalles

Chexbres-Village

Puidoux-Chexbres

d/p Lausanne

Puidoux-Chexbres

d/p Palézieux

51.56
1.50
50.07
1.47
1.73
3.20
2.85
6.05
1.16
7.21
0.70
7.91
1.18
9.09
1.00
10.09
3.30
13.39
2.87
16.25
3.27
19.53
3.39
22.91
3.89
26.80

0.00
0.85
0.90
1.75
3.86
5.61
1.49
7.10
0.73
7.83

51.56
1.50
50.07
1.47
1.73
3.20
2.85
6.05
1.16
7.21
0.70
7.91
1.18
9.09
1.00
10.09
3.30
13.39
2.87
16.25
3.27
19.53
3.39
22.91
3.89
26.80

0.00
0.85
0.90
1.75
3.86
5.61
1.49
7.10
0.73
7.83

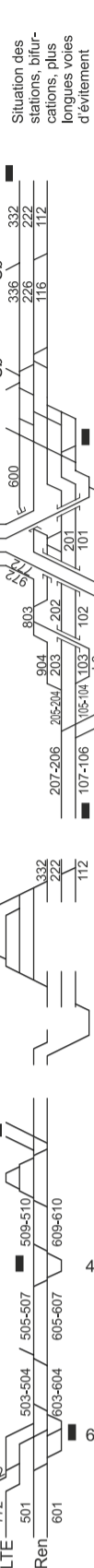
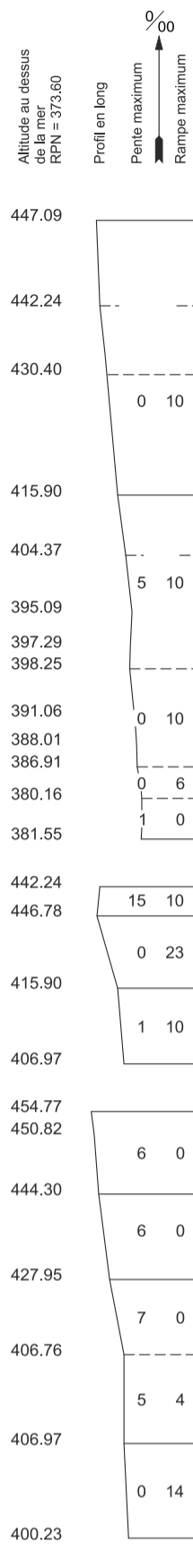
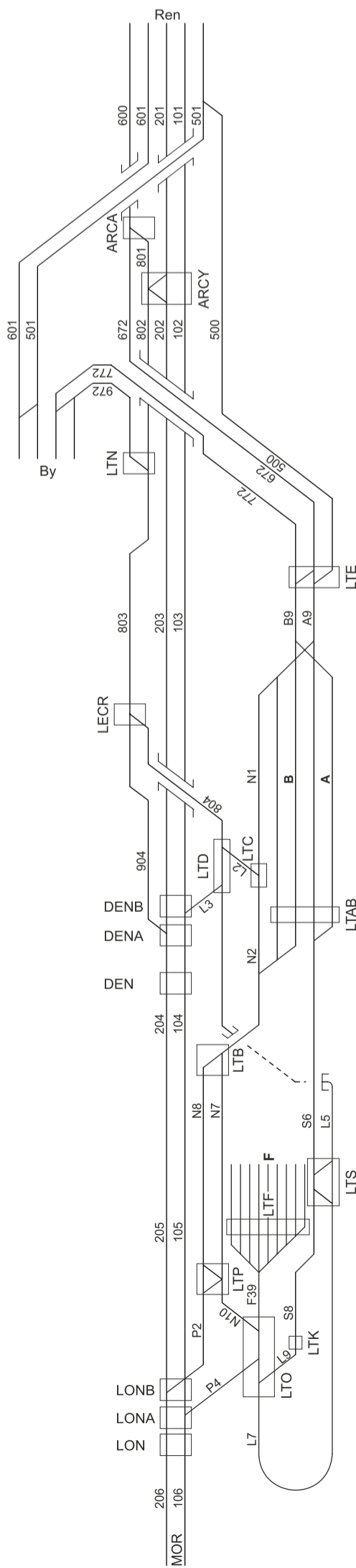

Stations de block

d/p Vevey

Lausanne

d/p Palézieux

Lausanne

Lausanne

Lausanne (bif)

Prilly-Malley

Renens VD Est (bif)

Renens VD Ouest (bif)

d/p Dailiens Archy (bif)

Venoge

Denges B (bif)

Denges A (bif)

Denges-Echandens

Denges Lonay B (bif)

Lonay A (bif)

Lonay-Préverenges

Morges-St-Jean

Morges

Lausanne (bif)

Lausanne-Sébeillon

Renens VD Est (bif)

Renens VD Ouest (bif)

Bussigny

Eclépens

Eclépens sud

d/p Vallorbe

Dailiens

Vaux

Cossonay

Gollion

Vufflens-la-Ville

Fallien

Bussigny

d/p LTN voie 972

Lausanne-Triage Est

Renens VD

Renens VD Ouest (bif) voie 500

Lausanne-Triage Est

Renens VD

Renens VD Ouest (bif) voie 600 Archy A (bif)

Lausanne-Triage Est voie 672

Lausanne-Triage Est voies A9/B9

Lausanne-Triage A/B

Lausanne-Triage B

Lausanne-Triage Est

Lausanne-Triage C

Lausanne-Triage B

Lausanne-Triage C

Lausanne-Triage B

Lausanne-Triage C

Lausanne-Triage B

Lausanne-Triage C

Lausanne-Triage B

Lausanne-Triage C

Lausanne-Triage B

Lausanne-Triage C

Lausanne-Triage B

Lausanne-Triage C

Lausanne-Triage B

Lausanne-Triage C

Lausanne-Triage B

Lausanne-Triage C

Lausanne-Triage B

Lausanne-Triage C

Lausanne-Triage B

Lausanne-Triage C

Lausanne-Triage B

Lausanne-Triage C

Lausanne-Triage B

Lausanne-Triage C

Lausanne-Triage B

Lausanne-Triage C

Lausanne-Triage B

Lausanne-Triage C

Lausanne-Triage B

Lausanne-Triage C

Lausanne-Triage B

Lausanne-Triage C

Lausanne-Triage B

Lausanne-Triage C

Lausanne-Triage B

Lausanne-Triage C

Lausanne-Triage B

Lausanne-Triage C

Lausanne-Triage B

Lausanne-Triage C

Lausanne-Triage B

Lausanne-Triage C

Lausanne-Triage B

Lausanne-Triage C

Lausanne-Triage B

Lausanne-Triage C

Lausanne-Triage B

Distance de stat. à stat.

Kilométrage de la voie

1.13

1.22

1.41

0.75

0.99

1.72

0.24

0.11

1.33

0.29

0.12

1.04

1.34

0.39

2.24

0.75

0.99

1.43

0.79

2.18

3.92

4.51

3.51

4.05

6.93

14.92

1.53

13.39

4.51

0.99

5.50

1.62

7.12

4.51

0.99

5.50

0.41

5.91

1.35

7.26

7.12

0.98

8.10

0.40

8.50

7.12

0.84

7.96

0.54

8.50

0.91

9.41

0.31

9.72

0.30

10.00

8.10

0.84

9.38

8.94

11.59

0.70

10.89

0.24

10.65

9.40

0.30

9.70

14.92

1.08

13.84

7.96

0.26

7.70

7.72

0.31

8.03

8.27

0.91

7.36

4.51

0.99

5.50

0.41

5.91

0.22

6.12

0.62

6.75

13.84

0.63

13.21

0.36

12.85

1.37

11.48

1.67

9.81

0.51

9.72

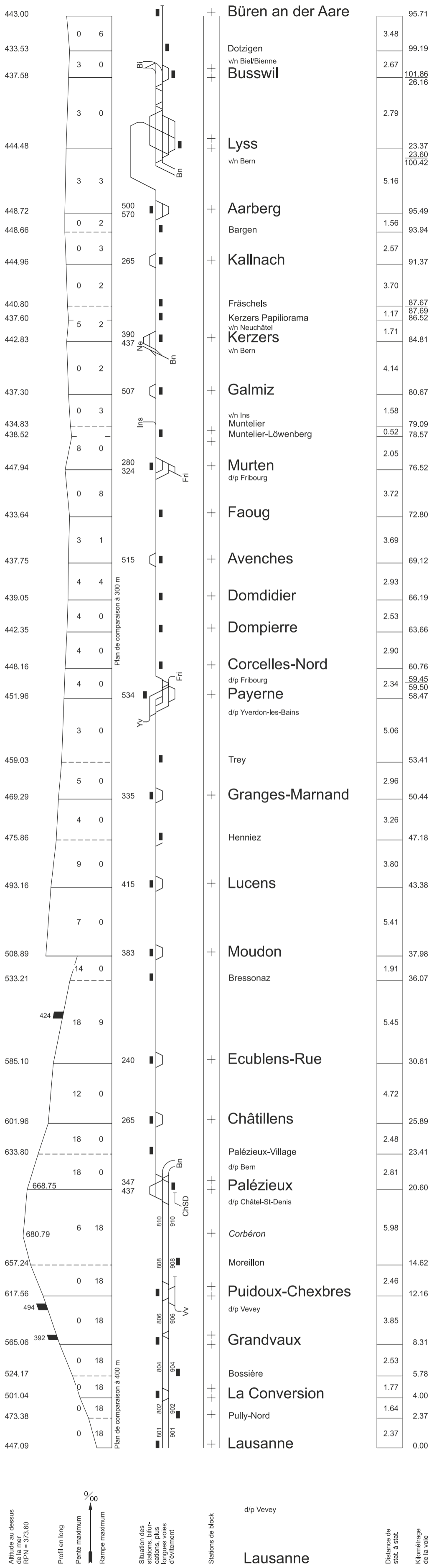

Altitude au dessus de la mer (RPN = 373.60)

Profil en long

Pente maximum

Rampe maximum

0/00

Situation des stations, bifurcations, plus longues voies d'évitement

Stations de block

d/p Vevey

Lausanne

d/p Renens

Distance de stat. à stat.

Kilométrage de la voie

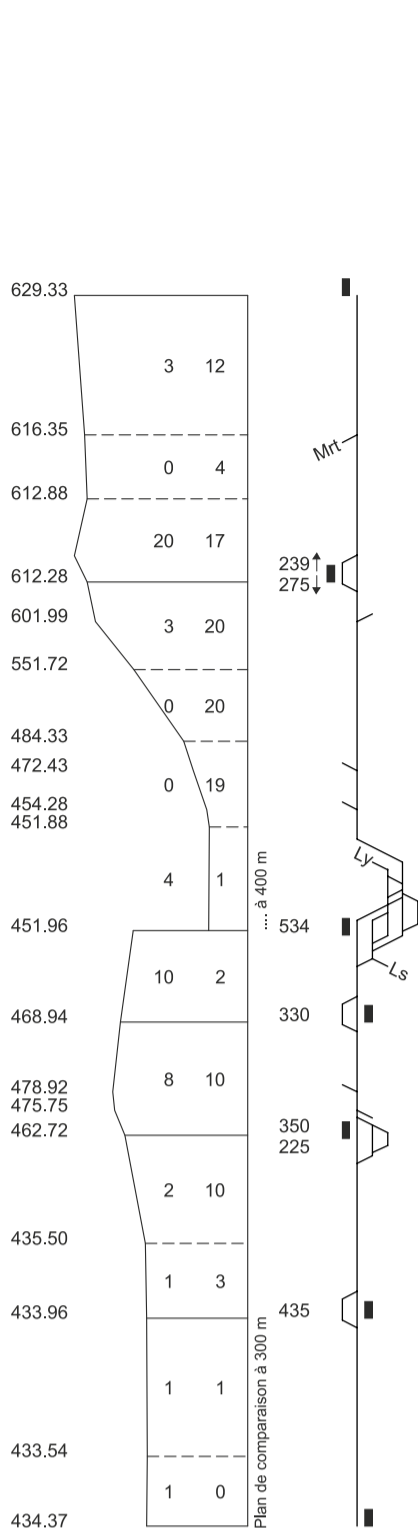

Altitude au dessus de la mer RPN = 373.60
Profil en long
Pente maximum
Rampe maximum
Situation des stations, bifurcations, plus longues voies d'évitement

d/p Lausanne

Fribourg

d/p Bern

Fribourg

Station	Distance de stat. à stat.	Kilométrage de la voie
Fribourg	4.00	49.92
Givisiez d/p Murten	1.47	45.92
Belfaux CFF	4.33	44.45
Grolley	2.09	40.12
Léchelles Tanklager (embr)	2.55	38.03
Léchelles	3.71	35.48
Cousset	0.73	31.77
Bossy Moulins (embr)	1.05	31.04
Bossy Bois (embr)	0.26	29.99
Corcéelles-Sud	1.84	29.73
d/p Lyss	1.84	27.89
Payerne	4.21	27.89
d/p Lausanne	4.21	27.89
Cugy FR	3.65	23.68
Sévaz (embr)	0.56	20.03
Siporex (embr)	1.40	19.47
Estavayer-le-Lac	5.45	18.07
Cheyres	3.81	12.62
Yvonand	7.03	8.81
Yverdon-Champ Pittet	1.78	1.78
Yverdon-les-Bains	1.78	0.00
		39.13

d/p Lausanne

Yverdon-les-Bains

d/p Neuchâtel

d/p Lausanne

Fribourg

d/p Bern

Fribourg

Station	Distance de stat. à stat.	Kilométrage de la voie
Fribourg	4.00	49.92
Givisiez d/p Murten	1.47	45.92
Belfaux CFF	4.33	44.45
Grolley	2.09	40.12
Léchelles Tanklager (embr)	2.55	38.03
Léchelles	3.71	35.48
Cousset	0.73	31.77
Bossy Moulins (embr)	1.05	31.04
Bossy Bois (embr)	0.26	29.99
Corcéelles-Sud	1.84	29.73
d/p Lyss	1.84	27.89
Payerne	4.21	27.89
d/p Lausanne	4.21	27.89
Cugy FR	3.65	23.68
Sévaz (embr)	0.56	20.03
Siporex (embr)	1.40	19.47
Estavayer-le-Lac	5.45	18.07
Cheyres	3.81	12.62
Yvonand	7.03	8.81
Yverdon-Champ Pittet	1.78	1.78
Yverdon-les-Bains	1.78	0.00
		39.13

d/p Lausanne

Yverdon-les-Bains

d/p Neuchâtel

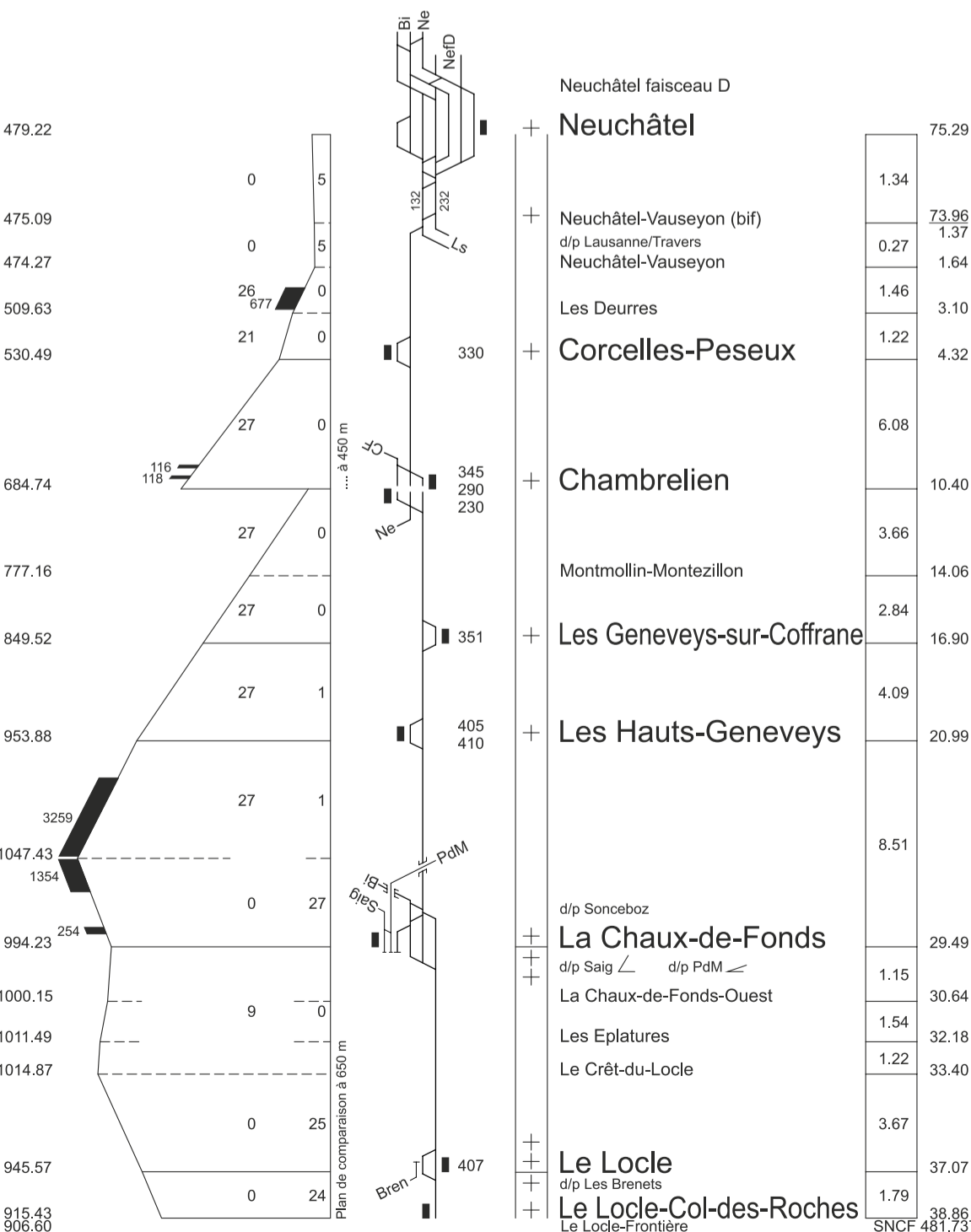
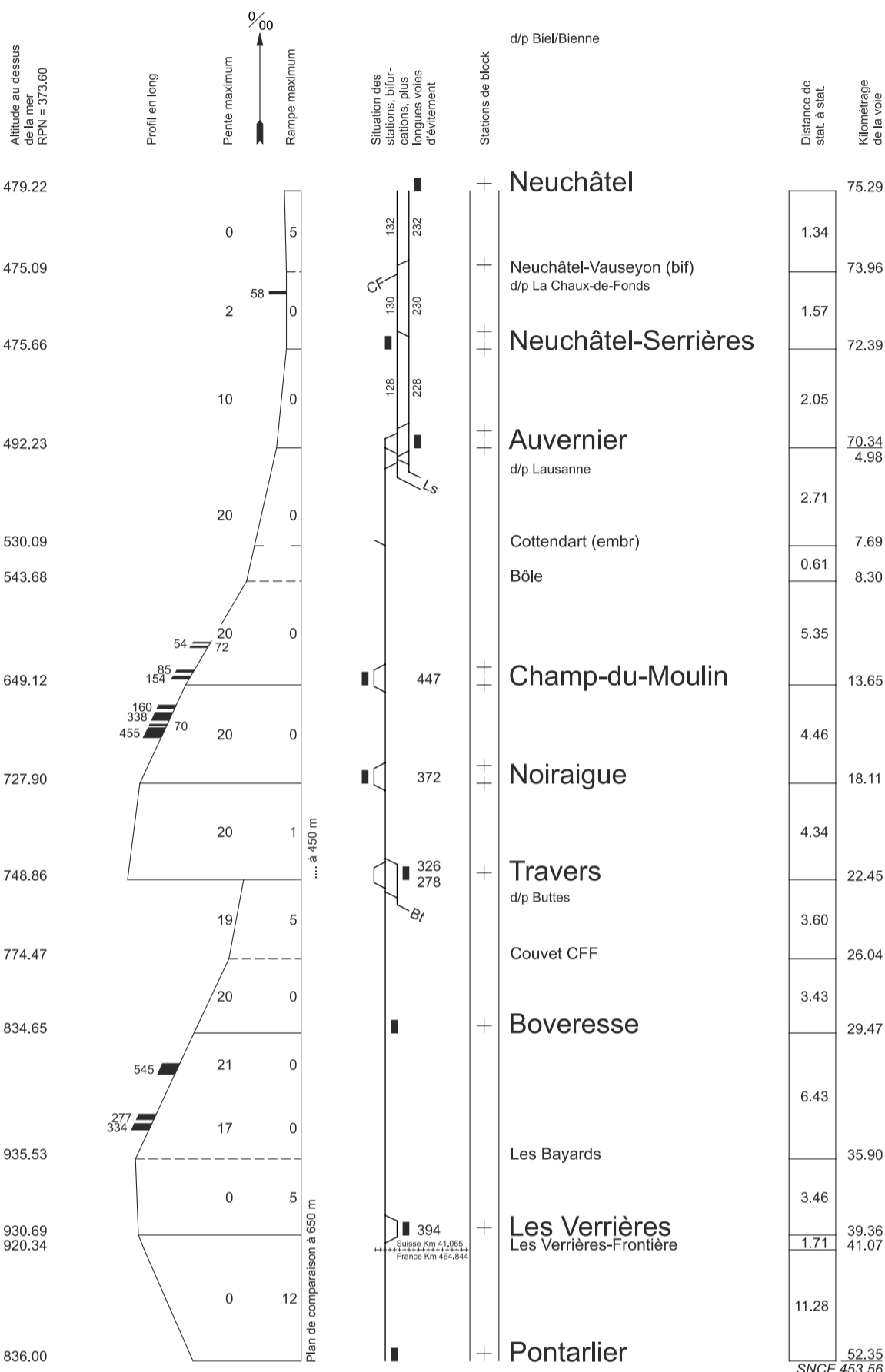

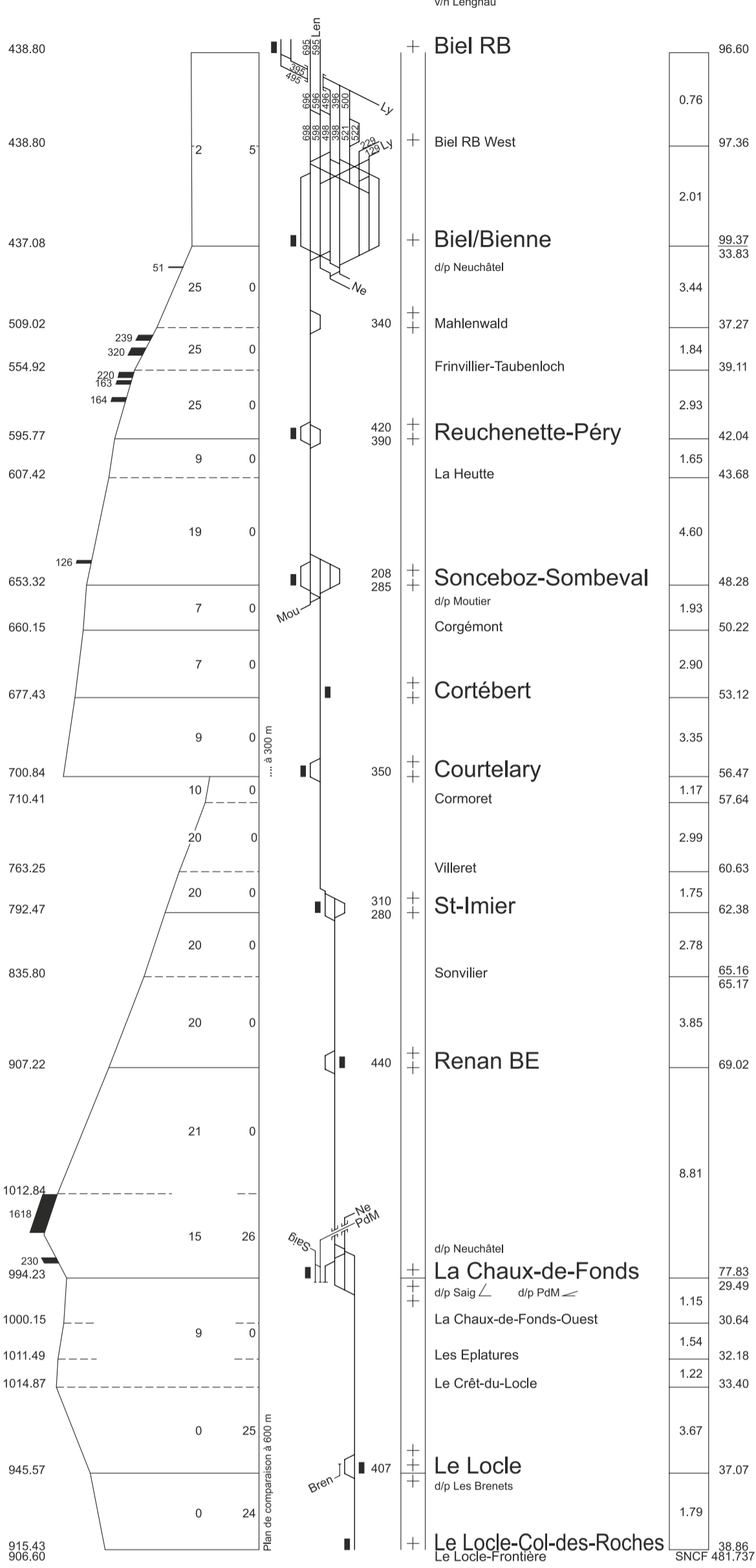

Altitude au dessus de la mer (RPN = 373.60)
 Profil en long
 Pente maximum (‰)
 Rampe maximum
 Situation des stations, bifurcations, plus longues voies d'évitement
 Stations de block
 Distance de stat. à stat.
 Kilométrage de la voie

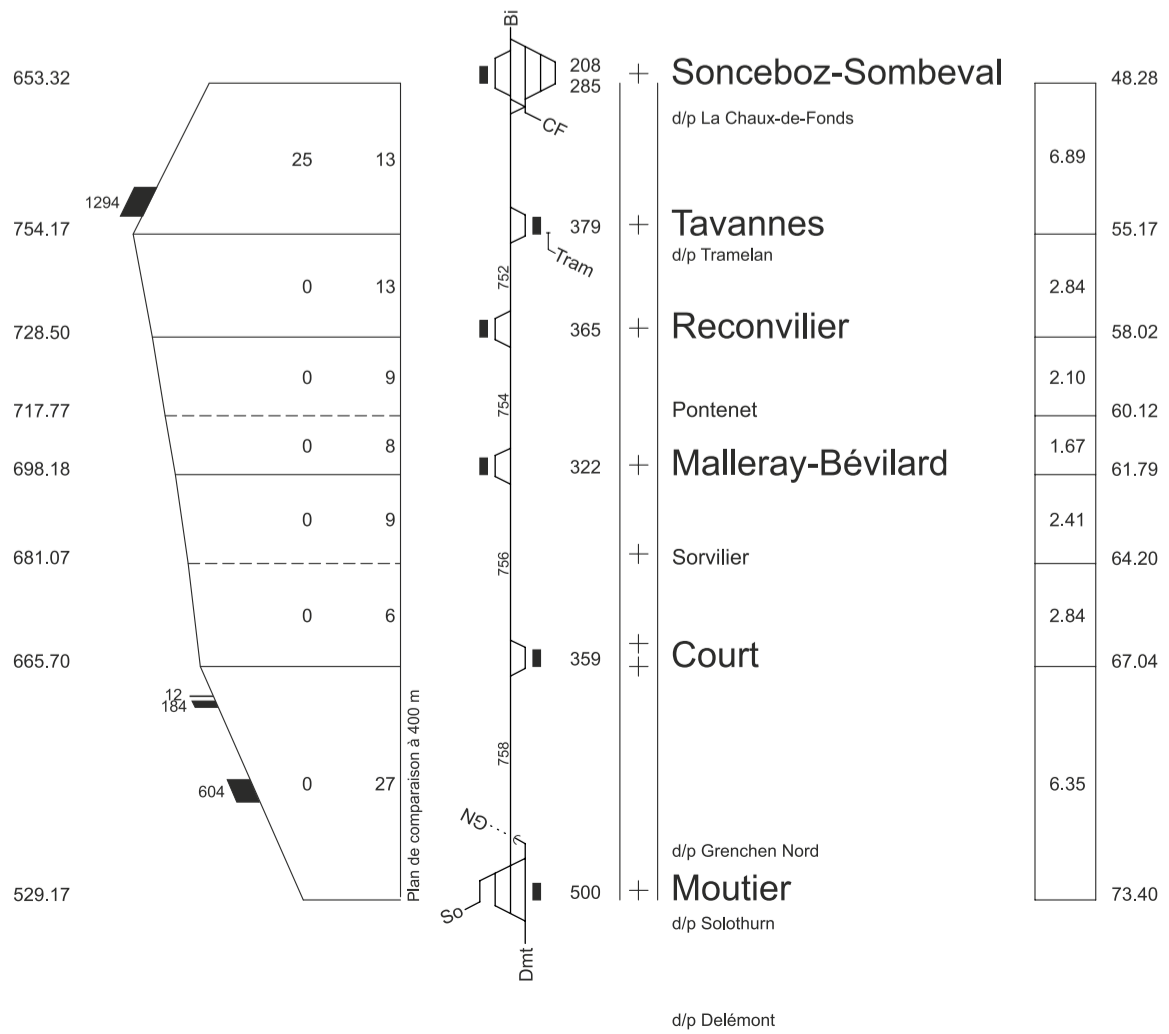

Altitude au dessus de la mer (RPN = 373.60)
 Profil en long
 Pente maximum (‰)
 Rampe maximum
 Situation des stations, bifurcations, plus longues voies d'évitement
 Stations de block
 Distance de stat. à stat.
 Kilométrage de la voie

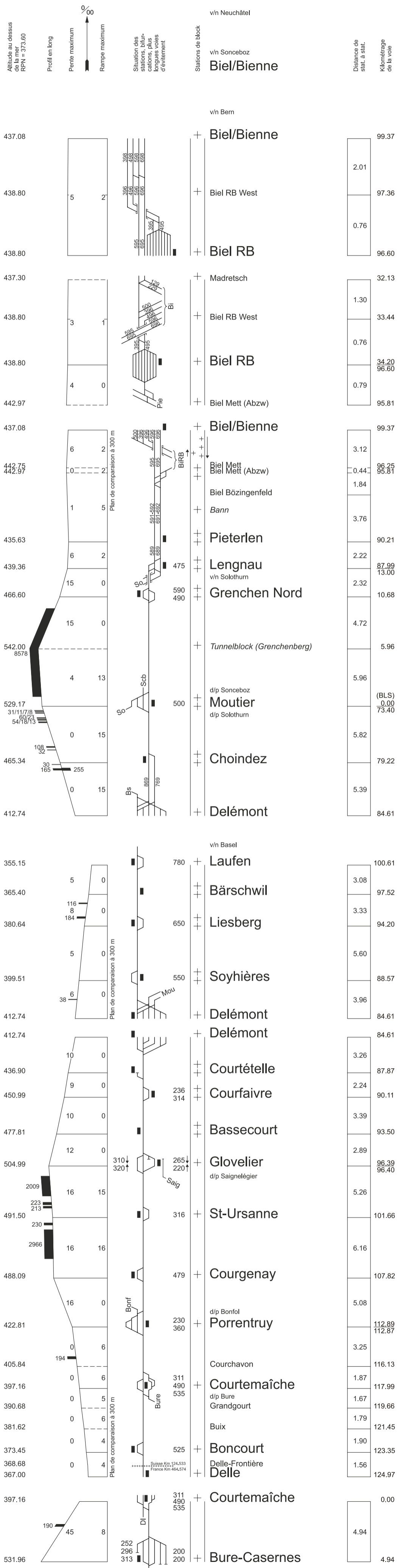

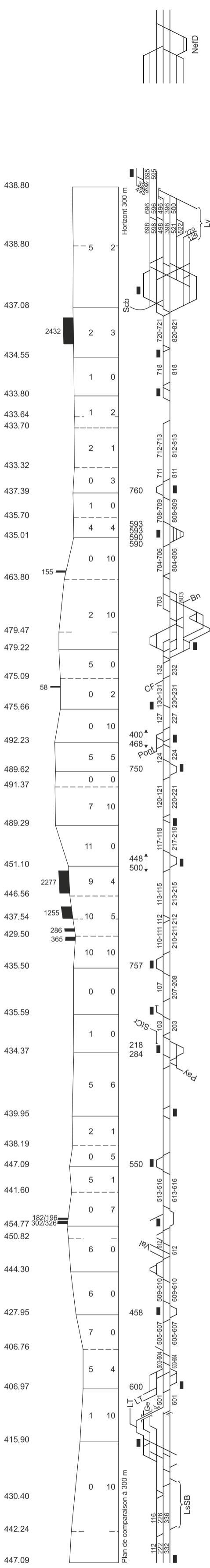

Altitude au dessus de la mer
 RPN = 373.60

Profil en long

Rampe maximum
 ↑
 Pente maximum
 ↓

Situation des stations, bifurcations, plus longues voies d'évitement

Neuchâtel-Mail	76.14
Neuchâtel faisceau D	75.58
Neuchâtel	75.29
d/p Lengnau	
Biel/Bienne	
Biel RB	96.60
Biel RB West	97.36
Biel/Bienne d/p Sonceboz <i>Vingelz</i>	99.37 104.50
Tüscherz	99.95
Twann	95.98
Ligerz Chavannes	94.00 93.73
<i>Poudelle</i>	3.68
La Neuveville	90.05
Le Landeron	87.72
Cressier NE	85.55
Cornaux <i>Souaillon</i>	83.60
St-Blaise CFF <i>La Coudre</i>	79.37
Neuchâtel-Mail Neuchâtel	76.14 75.29
Neuchâtel-Vauseyon (bif) d/p La Chaux-de-Fonds	73.96
Neuchâtel-Serrières	72.39
Auvernier d/p Pontarlier/Buttes	70.34
Colombier Boudry <i>Perreux</i>	67.67 66.25
Bevaix <i>Chassagne</i>	62.28
Gorgier-St-Aubin	58.10 57.89
Vaumarcus	54.85
La Lance (diag é) Concise	52.45 50.75
Onnens-Bonvillars	47.48
Grandson d/p Ste-Croix	42.71
Yverdon-les-Bains d/p Payerne <i>Champs-Lovats</i>	39.13
Ependes	32.70
Essert-Pittet d/p Orbe Chavornay	29.67 27.46
Bavois	24.88
Eclépens Eclépens sud d/p Vallorbe	21.38 20.59
Daillens <i>Vaux</i>	18.41
Cossonay <i>Gollion</i>	14.49
Vufflens-la-Ville <i>Faillen</i>	10.97
Bussigny d/p Lausanne-Triage d/p Genève Renens VD Ouest (bif)	6.93 1.43 5.50
Renens VD Renens VD Est (bif)	0.99 0.76 3.75
Prilly-Malley	2.35
Lausanne (bif)	1.13
Lausanne d/p Palézieux	0.00

Stations de block

d/p Vevey

voie N2
voie A9/B9

Distance de stat. à stat.

Kilométrage de la voie

voie L7

Ls-Triage A/B
 Ls-Triage B
 Ls-Triage Sud

Ls-Triage F
 Ls-Triage Ouest

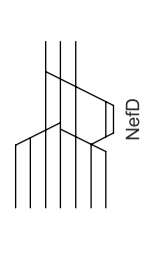

Höhen über Meer
RPN = 373.60

Längenprofil
Grösstes Gefälle
Grösste Steigung

Stationslage
Abzweigungen
Längste Ausweichgleise

Blockstationen

Entf. von Stat. zu Stat.
Kilometrierung der Bahn

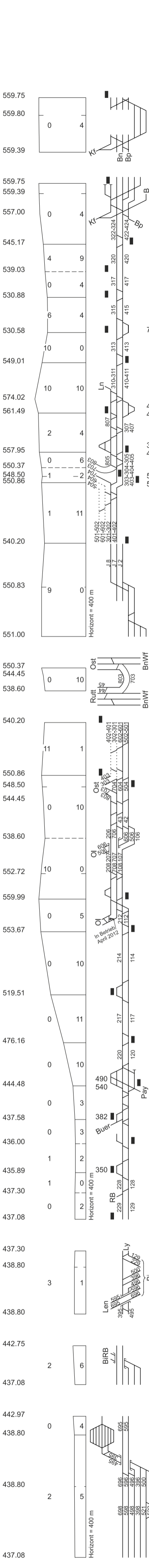

v/n Spiez

Thun Schadau (Abzw)

Thun
Thun Gruppe B

137.02
0.29
136.73
0.58
136.15

Thun (Abzw)

Thun
Thun (Abzw)

137.02
0.87
136.15

Lerchenfeld

1.52

Allmend

3.53

Uttigen

131.10

Kiesen

2.79

Wichtrach

128.30
2.57

Münsingen

125.73
3.60

Rubigen

122.13
3.09

Allmendingen
v/n Langnau

119.04
3.67

Gümligen Süd (Abzw)

115.37
1.41

Gümligen

113.96

Dennigkofen

3.19

Ostermündigen

110.77
1.28

Wankdorf (Abzw)

109.48
0.51

Bern Wankdorf

108.97
0.39

Bern Wylerfeld

108.58
0.39
103.33

Gl. 300 / 400

Lorraine

2.80

Bern

106.16
97.10

Bern JKLM

0.78

Bern JKLM

96.32
1.32

Bern Weyermannshaus

95.00

Wankdorf (Abzw)

103.17

Löchligut Süd (Abzw)

0.67

Löchligut

1.22
101.28

Bern

106.16

Lorraine

Gl. 500 / 600

2.83

Bern Wylerfeld

103.33

Bern Wankdorf

0.38

Löchligut Süd (Abzw)

0.45
102.50

Löchligut

1.22

v/n Olten

101.28

Zollikofen West (Spw)

1.40

Zollikofen

99.88
99.86

v/n Olten

1.05

Münchenbuchsee

98.81
(7.46)
2.66

Schüpfen

10.12
5.57

Suberg-Grossaffoltern

15.69
4.23

Lyss

19.92
3.44

v/n Payerne

23.37

Busswil

26.16

v/n Büren a. d. Aare

1.96

v/n Studen Auto

2.39

Brügg BE

30.51

Madretsch

32.13
33.07

v/n Biel RB

98.84

Biel/Bienne

99.37

Madretsch

32.13

Biel RB West

1.30

33.44
97.36

Biel RB

0.76

96.60

Biel Mett

96.25

Biel/Bienne

3.12

99.37

Biel Mett (Abzw)

95.81

Biel RB

0.79

96.60

Biel RB West

0.76

97.36

Biel RB West

2.01

Biel/Bienne

99.37

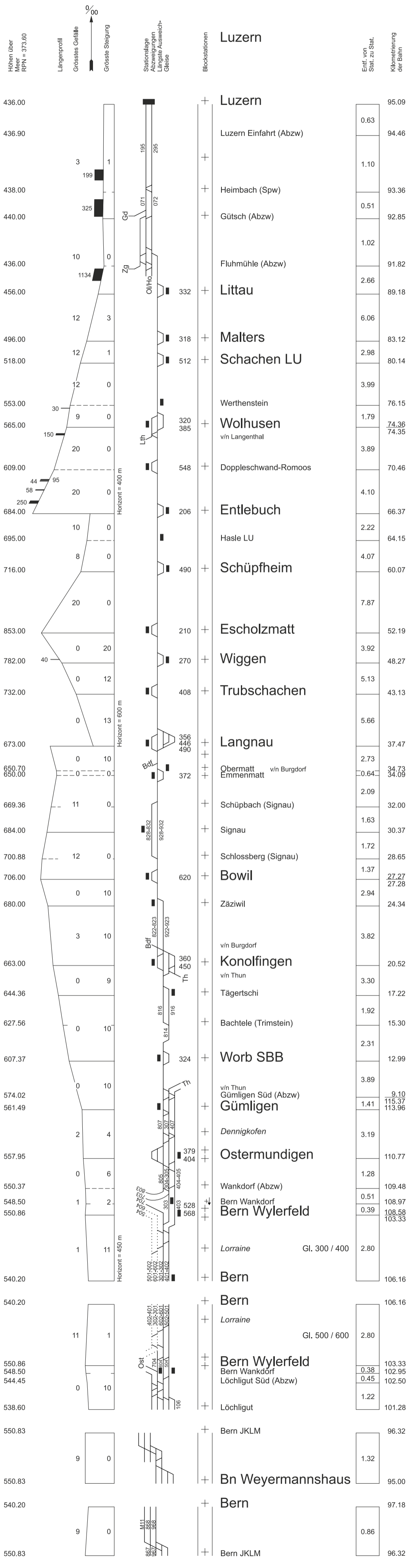

v/n Brüning

Luzern

Luzern

Littau

Malters
Schachen LU

Wolhusen

Entlebuch

Schüpfheim

Escholzmatt

Wigen

Trubschachen

Langnau

Obermatt v/n Burgdorf
Emmenmatt

Schüpbach (Signau)

Signau

Schlossberg (Signau)

Bowil

Zäziwil

Konolfingen

Tägertschi

Bachtele (Trimstein)

Worb SBB

Gümligen Süd (Abzw)

Gümligen

Dennigkofen

Ostermundigen

Wankdorf (Abzw)

Bern Wankdorf

Bern Wylerfeld

Lorraine

Bern

Bern

Bern Wylerfeld

Bern Wankdorf

Löchligut Süd (Abzw)

Löchligut

Bern JKLM

Bn Weyermannshaus

Bern

Bern JKLM

35 A

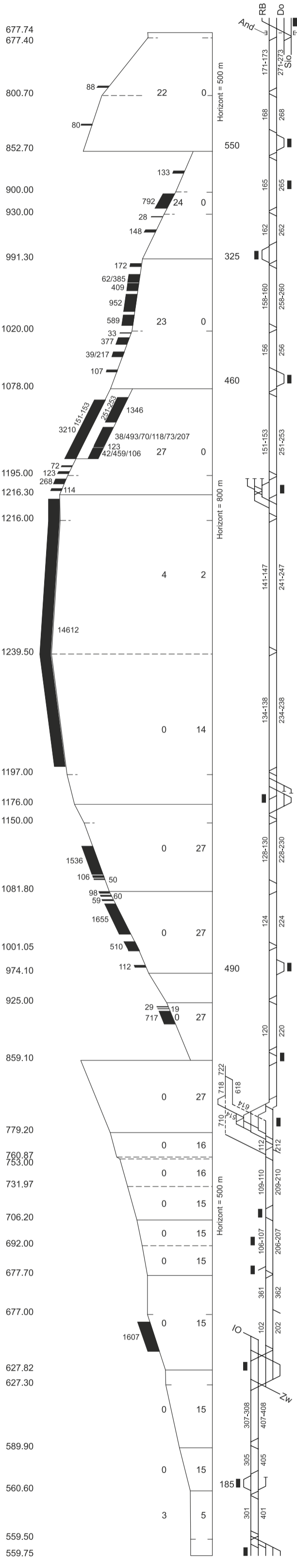

Höhen über Meer = 373.60
RPN = 373.60

Längenprofil

Grösstes Gefälle

Grösste Steigung

Stationslage
Abzweigungen
Längste Ausweiche
Gleise

v/n Domodossola

Brig	73.81
Brig-Lötschberg (Abzw)	73.51
Mundbach (Spw)	70.35
Lalden	67.29
Eggerberg	64.99
Viktoria (Spw)	63.70
Ausserberg	61.27 61.28
Rarnerkumme (Spw)	57.30
Hohtenn	54.19
Stockgraben (Spw)	49.46
Goppenstein	48.44
Goppenstein Lötschberg (Spw)	47.03
Tunnelstation Lötschberg (Spw)	39.76
Eggenschwand (Spw)	33.26
Kandersteg	31.57
Bühl (Spw)	30.50
Felsenburg	26.78
Fürten (Spw)	23.68
Blausee-Mitholz	22.35
Grubi (Spw)	20.65
Kandergrund	17.45
Frutigen	13.54
Winklen (Spw)	12.03
Wengi (AnG)	11.87
Wengi-Ey (Abzw)	10.28 9.97 9.97
Reichenbach im Kandertal	8.29
Mülenen	6.85
Heustrich-Emdthal	5.16
Hondrich Süd (AnG)	2.99 2.90
Spiez	3.00
Spiez (Abzw)	0.89 8.90
Einigen	5.44
Gwatt	3.10
Thun Schadau (Abzw)	0.49
Thun	137.59

Wichtiger Hinweis:
Um die Lesbarkeit des Fahrplanes zu erhöhen, wurde auf die Darstellung der Verkehrsperioden (VP) bei den Zügen der Serie 28000-28999 verzichtet.

Thun
Thun Gruppe B
Thun (Abzw)
Thun (Abzw)
Lerchenfeld

Entf. von Stat. zu Stat.
Kilometrierung der Bahn

v/n Bern

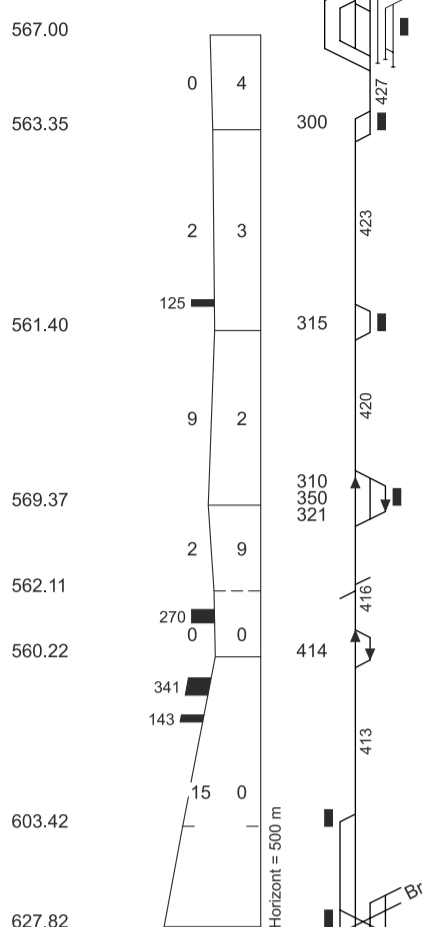

v/n Meiringen

v/n Zweilütschinen

Interlaken Ost

+	Interlaken Ost	27.95
+	Interlaken West	1.93
+	Därligen	4.01
+	Leissigen	22.02
+	Leissigbad (Agl)	3.52
+	Krattighalde	18.50
+		18.49
+		1.79
+		16.70
+		1.30
+		15.40
+		3.44
+	Faulensee	11.96
+		11.88
+	Spiez	2.02
		9.78

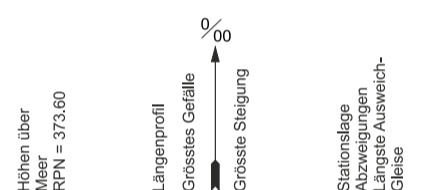

v/n Brig

Spiez

Spiez (Abzw)

Blockstationen	
v/n Thun	
Entf. von Stat. zu Stat.	Kilometrierung der Bahn

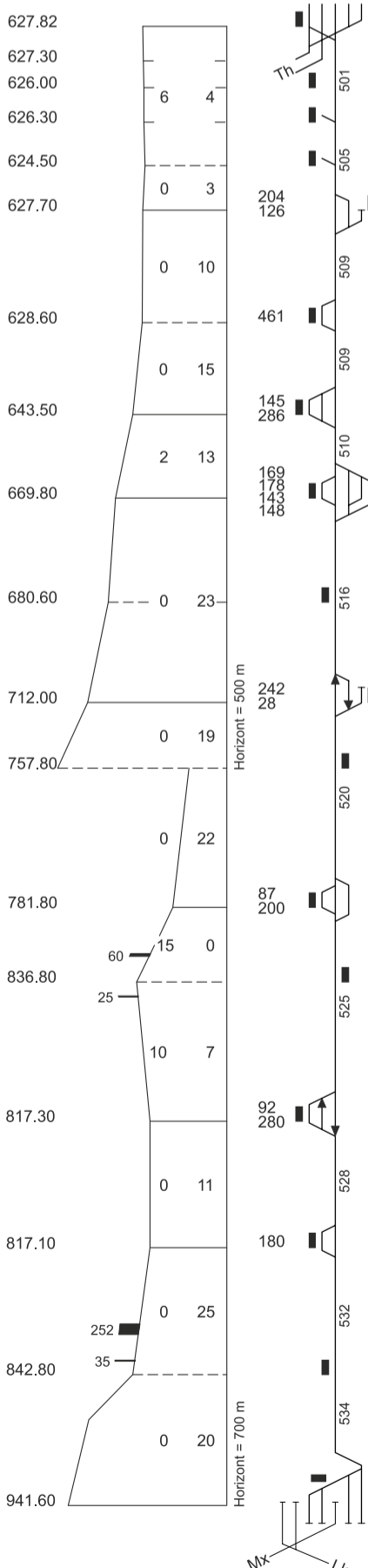

v/n Thun

Spiez

+	Spiez	0.00
+	Spiez (Abzw)	0.89
+	Spiezmoos Süd	0.69
+	Lattigen bei Spiez	1.57
+	Eifeld	0.88
+	Wimmis	2.45
+		1.04
+		3.49
+		1.05
+		4.54
+		2.61
+	Burgholz	7.16
+		2.18
+	Oey-Diemtigen	9.33
+		1.96
+	Erlenbach im Simmental	11.29
+		2.50
+	Ringoldingen	13.79
+		2.31
+	Därstetten	16.10
+	Weissenburg	17.64
+		1.54
+		3.25
+	Oberwil im Simmental	20.90
+		1.73
+	Enge im Simmental	22.63
+		3.28
+	Boltigen	25.90
+		2.98
+	Weissenbach	28.89
+		2.94
+	Grubenwald	31.82
+		3.08
+	Zweisimmen	34.90

Zweisimmen

v/n Lenk

v/n Gstaad

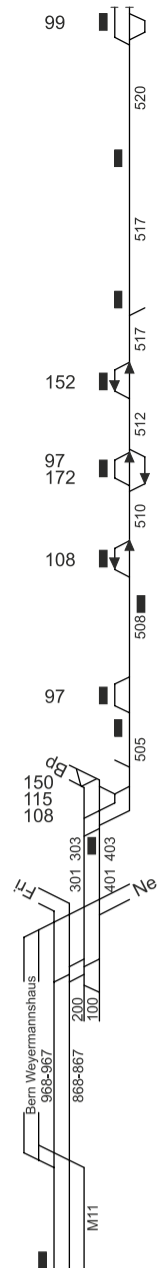
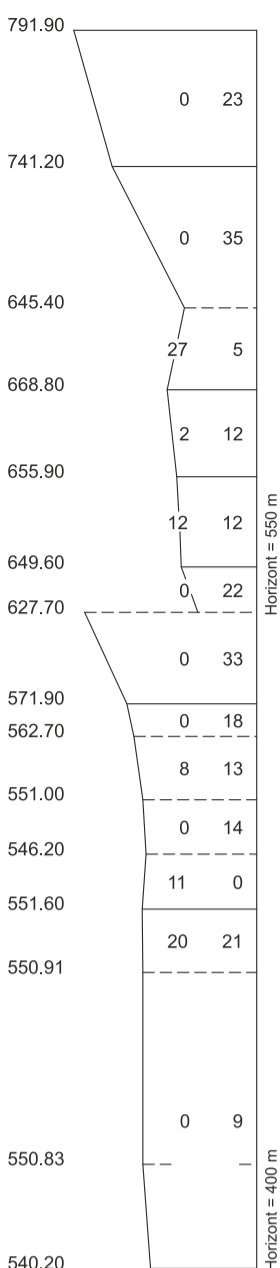

Blockstationen	Entf. von Stat. zu Stat.	Kilometrierung der Bahn
Bern	0.86	97.18
Bern JKLM		96.32
Bern Weyermannshaus (Spw)	1.41	2.23
Bern Holligen	0.48	2.71
Bern Ausserholligen GBS	0.41	3.12
Bern Fischerhätti (Abzw)	0.40	3.52
Köniz	0.72	5.00
Liebefeld	1.47	5.71
Moos	2.08	7.80
Gasel	1.08	8.87
Niederscherli	2.01	10.89
Mittelhäusern	1.94	12.82
Schwarzwasserbrücke	1.83	14.66
Lanzenhäusern	3.18	17.83
Schwarzenburg	3.04	20.87

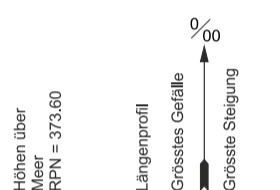

Blockstationen	Entf. von Stat. zu Stat.	Kilometrierung der Bahn
Thun		
Thun (Abzw)		

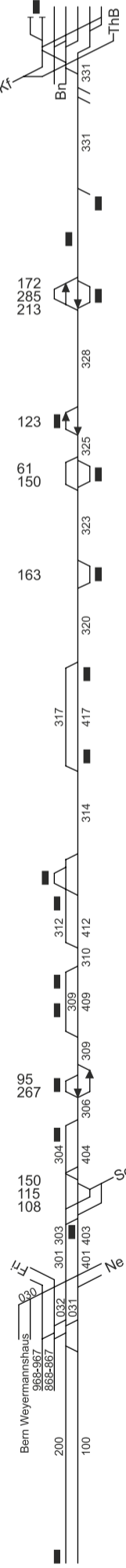
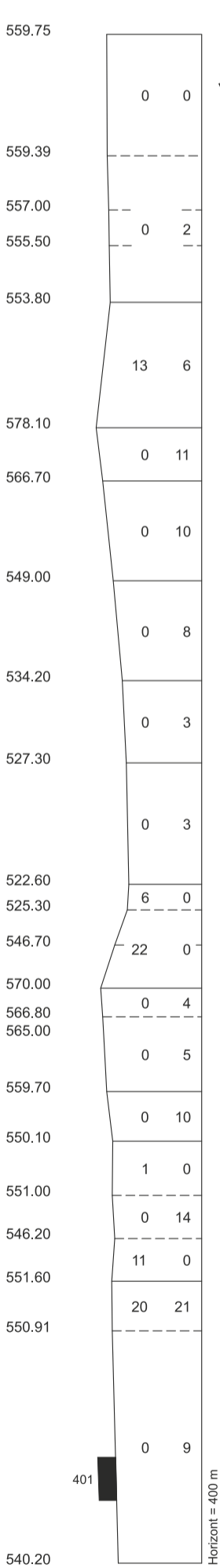

Blockstationen	Entf. von Stat. zu Stat.	Kilometrierung der Bahn
Bern	0.86	97.18
Bern JKLM		96.32
Bern Weyermannshaus (Spw)	1.41	2.23
Bern Holligen	0.48	2.71
Bern Ausserholligen GBS	0.41	3.12
Bern Fischerhätti (Abzw)	0.40	3.52
Köniz	0.72	5.00
Liebefeld	1.47	5.71
Moos	2.08	7.80
Gasel	1.08	8.87
Niederscherli	2.01	10.89
Mittelhäusern	1.94	12.82
Schwarzwasserbrücke	1.83	14.66
Lanzenhäusern	3.18	17.83
Schwarzenburg	3.04	20.87
Thun	0.87	34.48
Thun (Abzw)	1.53	33.61
Lerchenfeld	1.08	32.08
Uetendorf Allmend	1.70	30.99
Uetendorf	3.58	29.30
Seftigen	1.52	25.72
Burgstein-Wattenwil	2.86	24.20
Thurnen	2.88	21.34
Kaufdorf	2.34	18.47
Toffen	3.43	16.13
Belp	0.78	12.70
Belp Steinbach	1.05	11.92
Falkenhaus (Spw)	1.21	10.87
Kehrsatz	0.89	9.67
Kehrsatz Nord	0.51	8.77
Breitenacker (Spw)	1.70	8.27
Wabern bei Bern	1.48	6.57
Bern Weissenbühl	1.57	5.09
Bern Fischerhätti (Abzw)	0.40	3.52
Bern Ausserholligen GBS	0.41	3.12
Bern Holligen	0.48	2.71
Bern Weyermannshaus (Spw)	2.18	2.23

Bern Holligen
Bern Steigerhubel (Abzw)
Bern Weyermannshaus

Bern JKLM

Bern

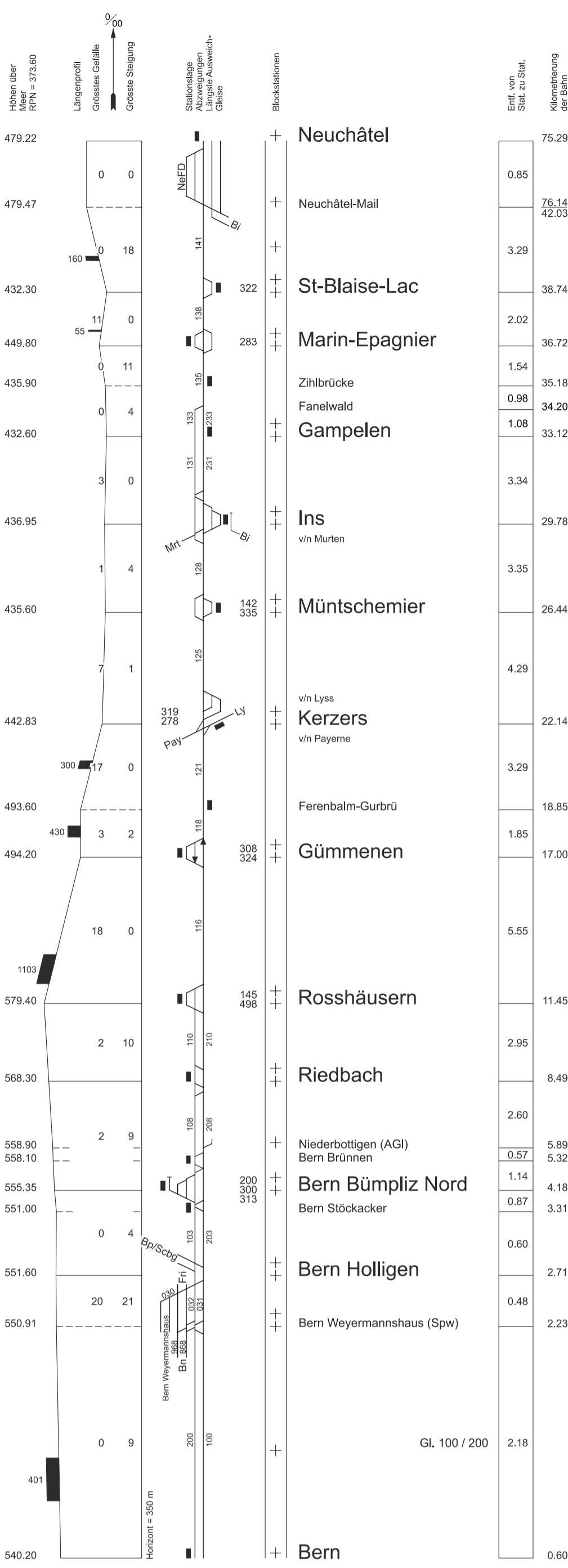

Bern Holligen

Bern Weyermannshaus (Spw)

Gleise 967 / 867

Bern JKLM

Gleise P (J2,J7,J8)

Bern

Bern Holligen
Bern Steigerhubel (Abzw)

Bern Weyermannshaus

Bern JKLM

Gleise G (J1, M11)

Bern

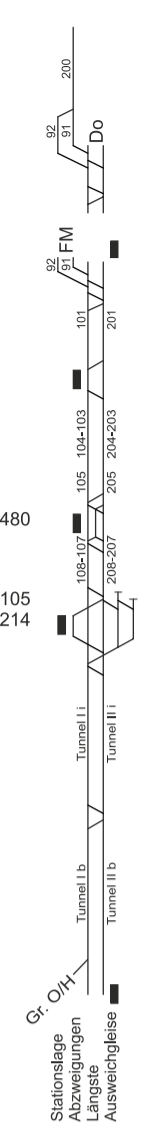
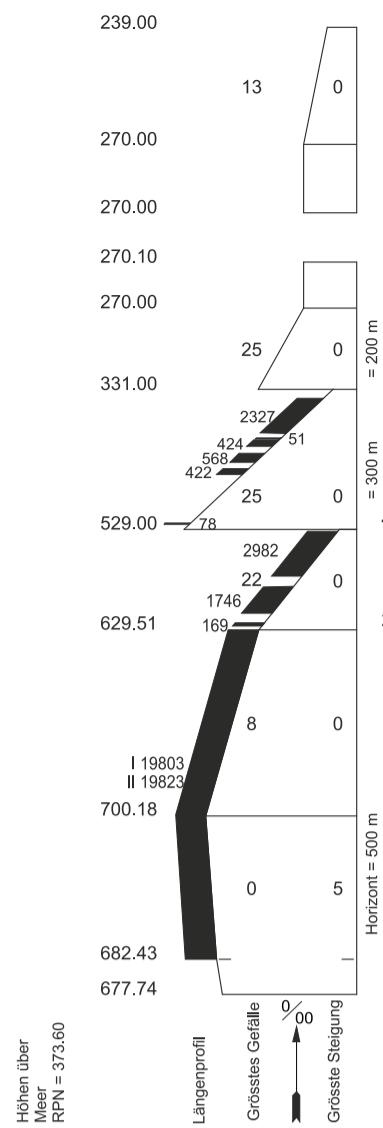

Domodossola II	191.34
Domodossola FM	186.12
Domodossola (bif)	185.04
Domodossola (bif)	186.28
Domodossola (bif)	185.04
Preglia	182.45
Rio Rido	8.71
Mognatta	8.71
Varzo	173.75
Galleria elicoidale	6.27
Iselle di Trasquera	167.48
Staz. della Galleria Sempione	156.35
Brig Tunnel	147.15
Brig	145.55

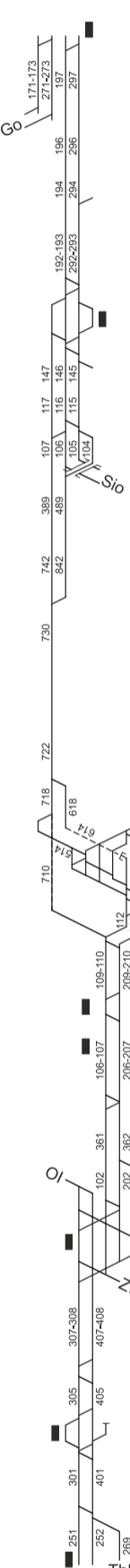
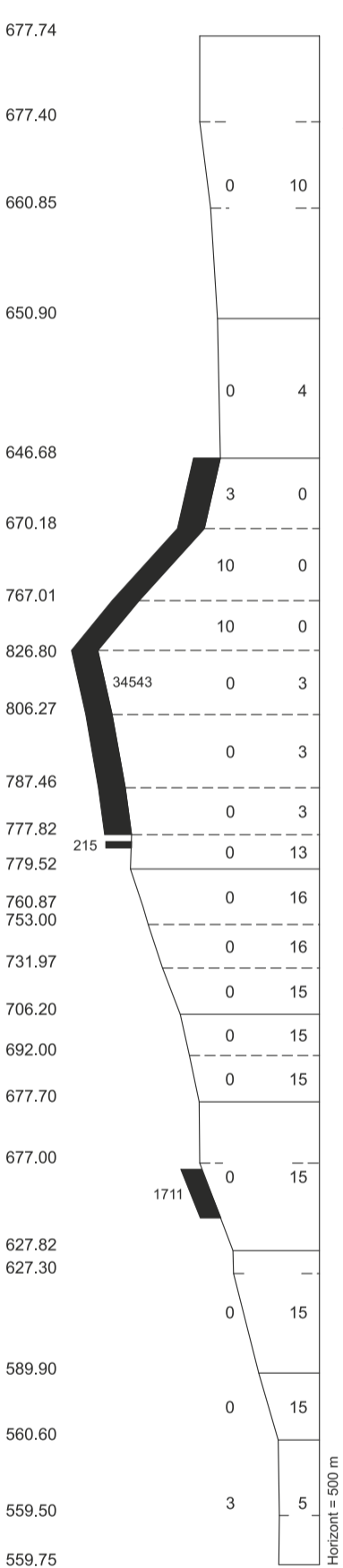

Brig	145.55
Brig Lötschberg (Abzw)	73.51
Brig Lötschberg (Abzw)	145.25
Gliser Grund	3.81
Gamsen SBB	141.44
Visp	136.73
St. German (Abzw)	133.40
Lötschen	43.84
Ferden (Spw)	35.22
Mitholz	22.02
Adelrain (Abzw)	15.76
Frutigen Nordportal (Abzw)	14.65
Frutigen	13.54
Winklen (Spw)	12.03
Wengi (AG)	11.87
Wengi-Ey (Abzw)	10.28
Reichenbach i/K.	8.29
Mülenen	6.85
Heustrich-Emdthal	5.16
Hondrich Süd (AGI)	2.99
Spiez	0.00
Spiez (Abzw)	8.90
Einigen	5.44
Gwatt	3.10
Thun Schadau (Abzw)	0.49
Thun	137.59

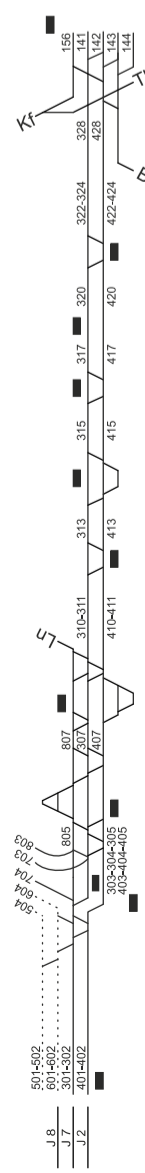
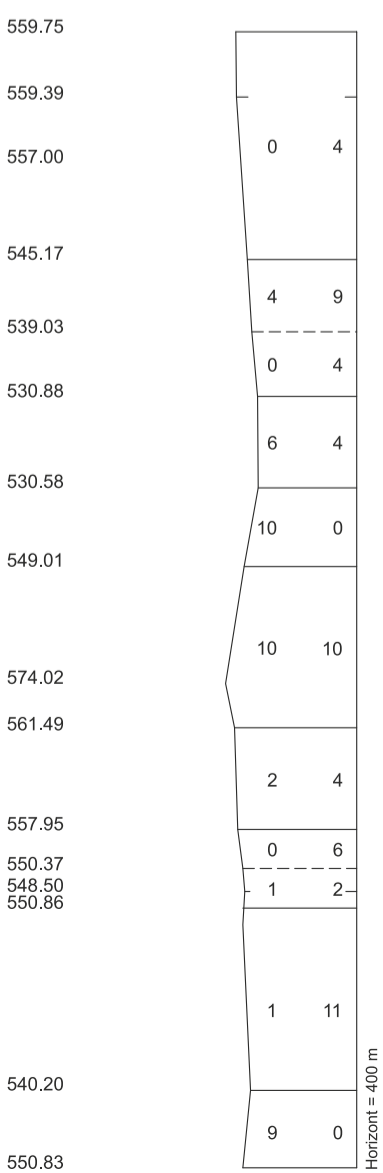

Thun	137.02
Thun (Abzw)	136.15
Lerchenfeld	134.63
Uttigen	131.10
Kiesen	128.30
Wichtrach	125.73
Münsingen	122.13
Rubigen	119.04
Allmendingen	115.37
Gümligen Süd (Abzw)	113.96
Gümligen	113.96
Dennigkofen	110.77
Ostermundigen	109.48
Wankdorf (Abzw)	108.97
Bern Wankdorf	108.58
Bern Wylerfeld	103.33
Lorraine	97.18
Bern	96.32
Bern JKLM	96.32

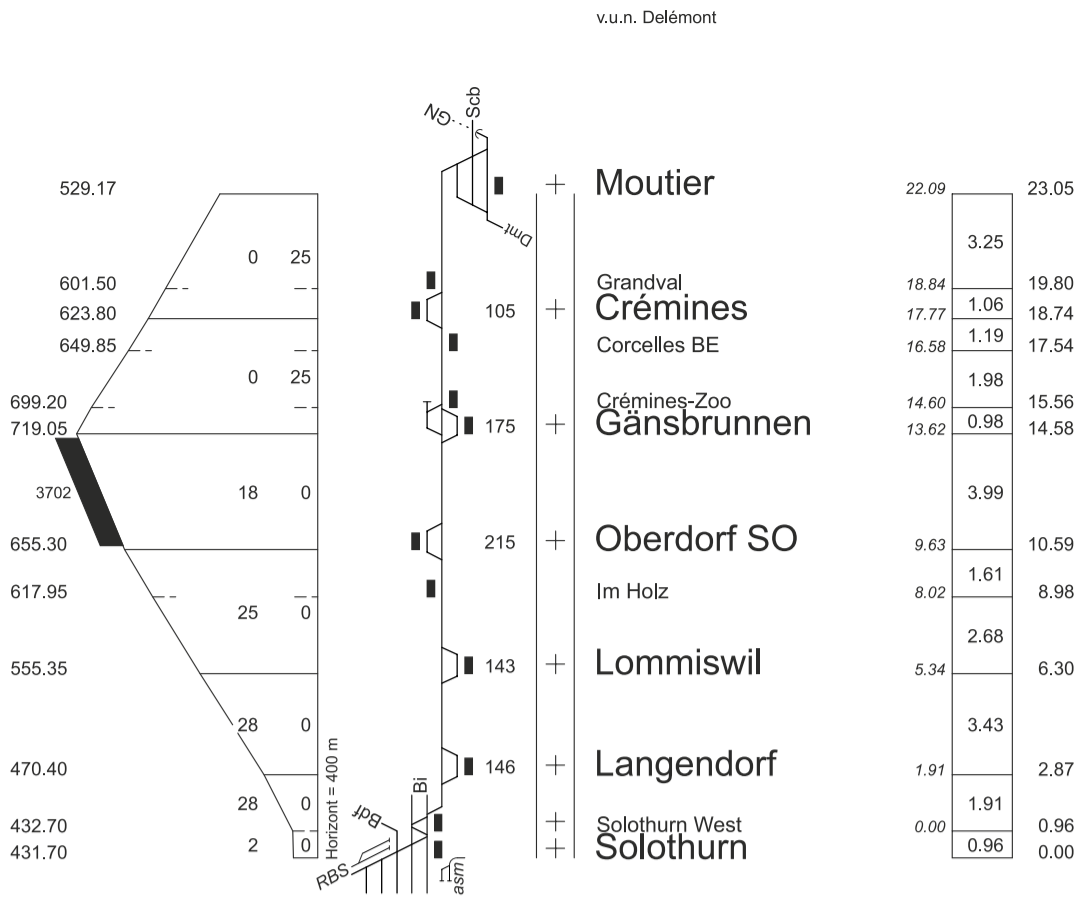

v.u.n. Delémont

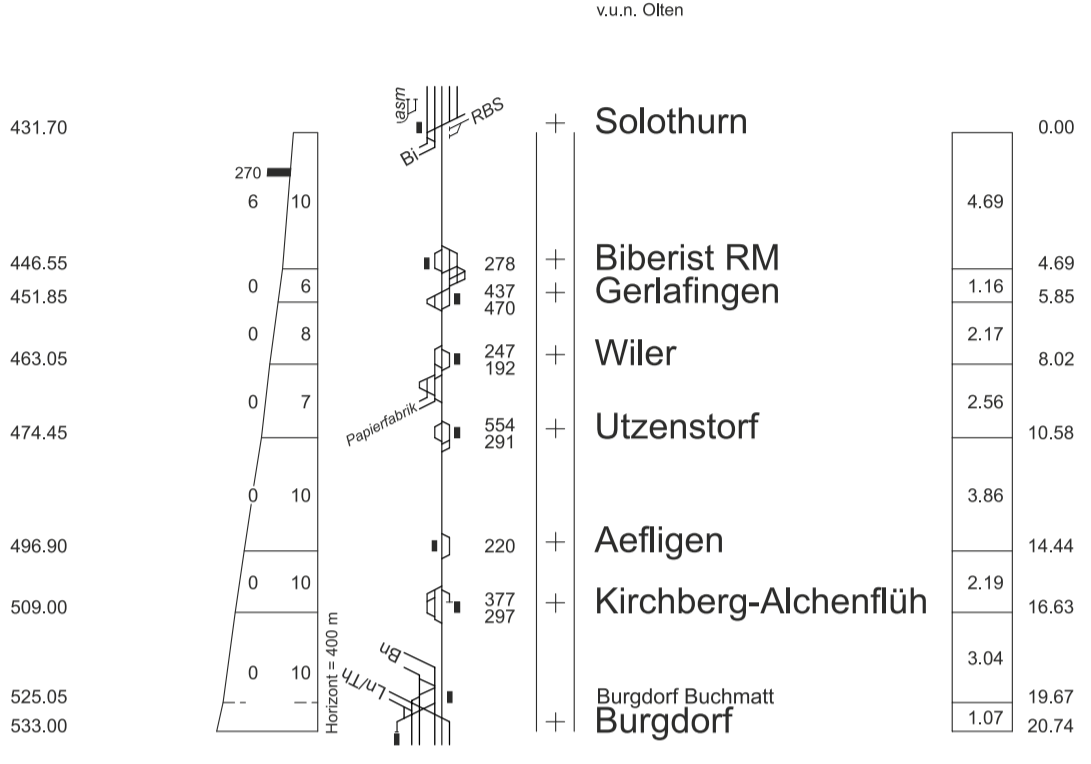

v.u.n. Olten

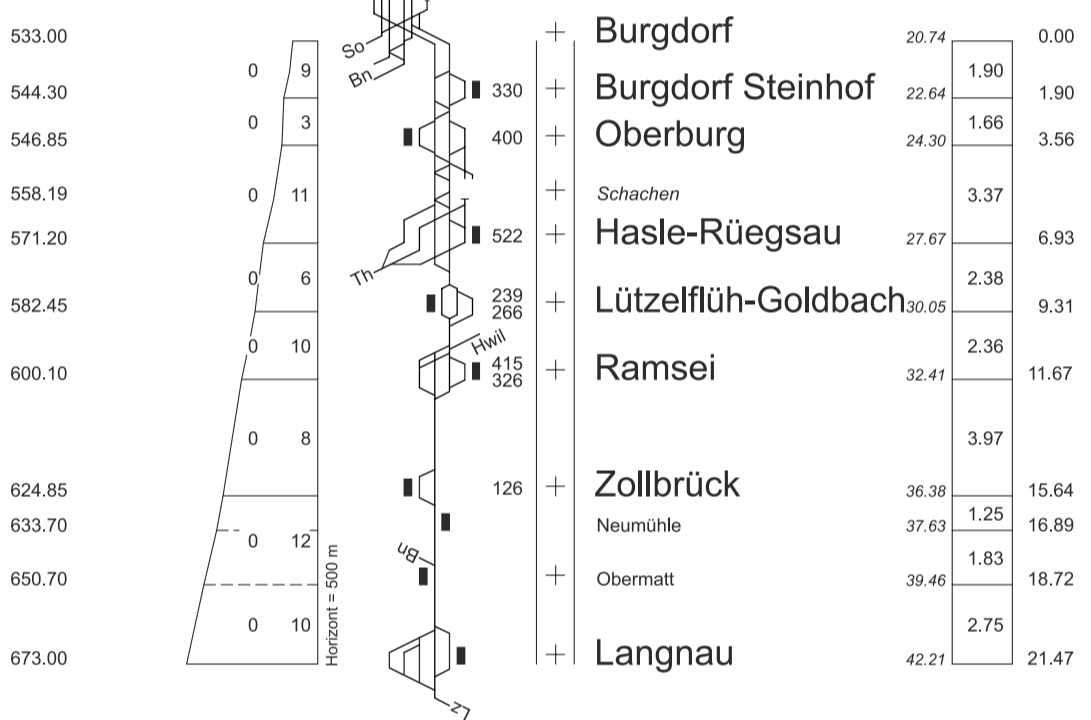

v.u.n. Luzern

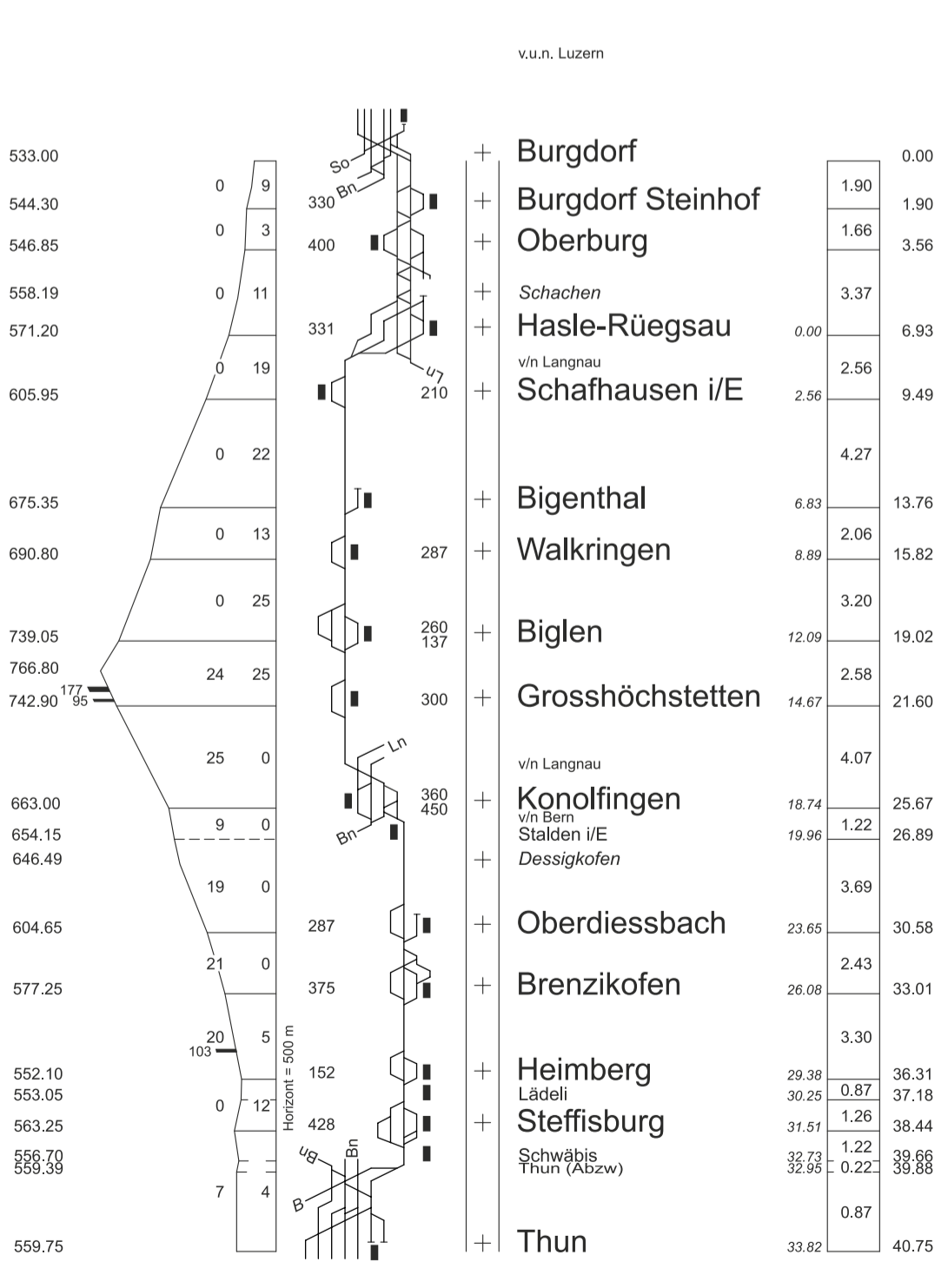

Thun (Abzw)

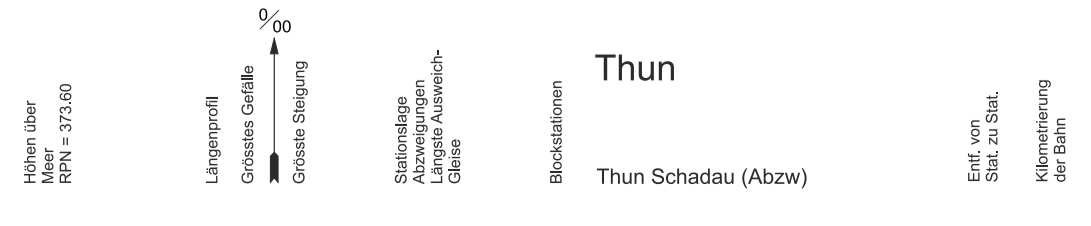

Thun

Thun Schadau (Abzw)

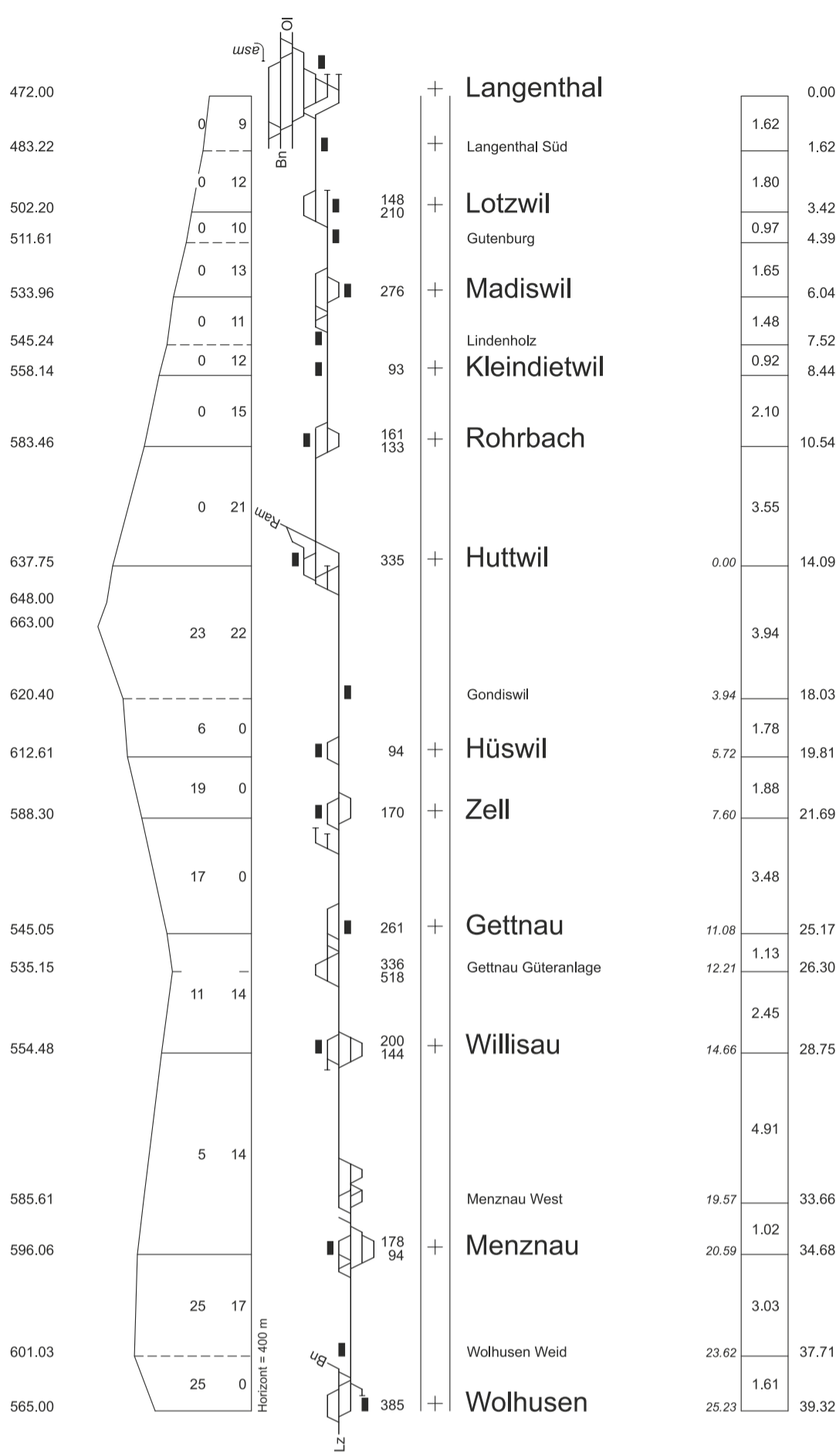

Höhen über Meer
RPN = 373.60

Längenprofil
Grösstes Gefälle
Grösste Steigung

Stationslage
Abzweigungen
Längste Ausweich-
Gleise

Blockstationen

Entf. von Stat. zu Stat.
Kilometrierung der Bahn

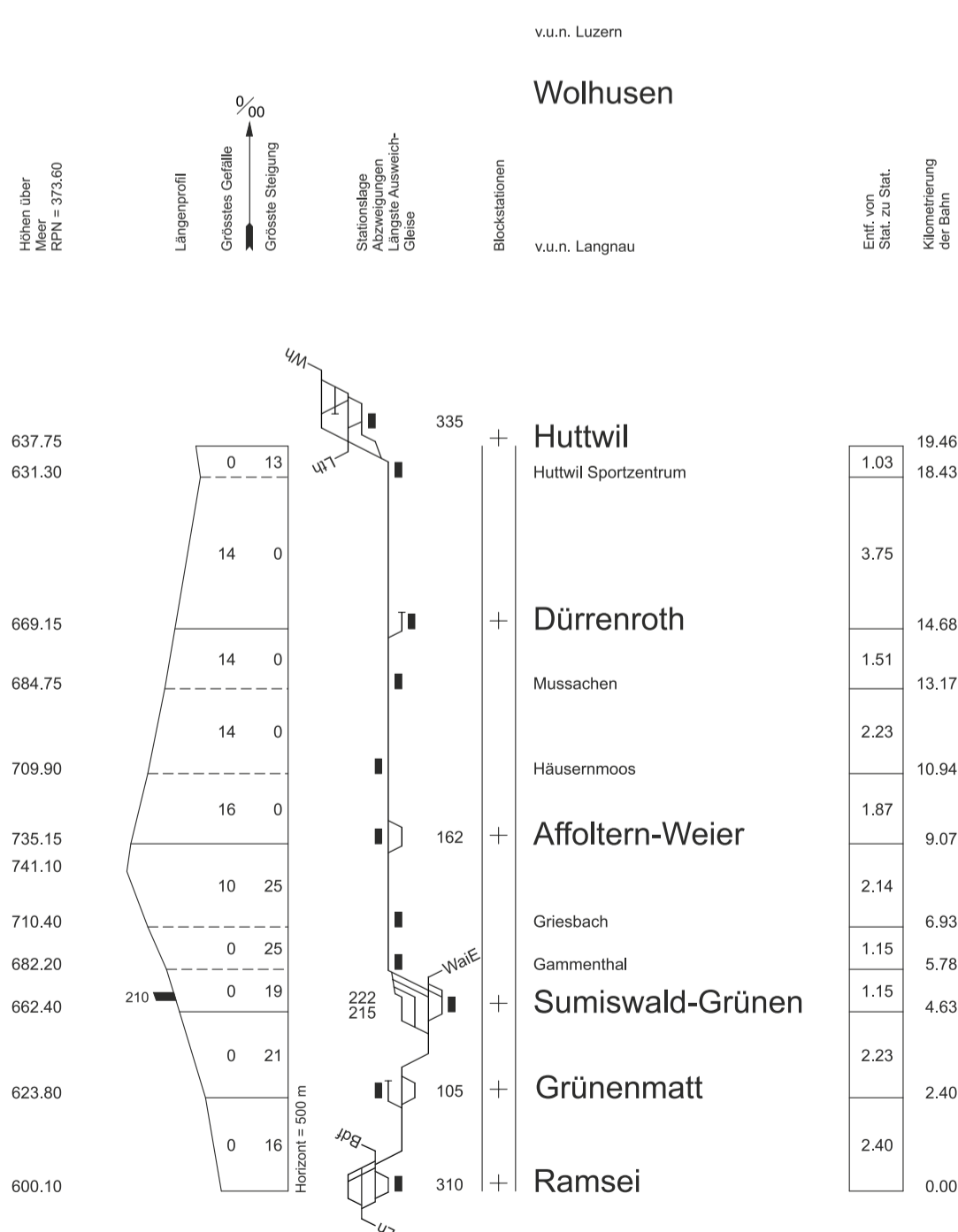

v.u.n. Burgdorf

Ramsei

v.u.n. Langnau

v.u.n. Olten

v.u.n. Bern



I-FN-FPA-RME

Ausgabe von 15.12.2013

v. u. n. Basel

OLTEN PB

v. u. n. Luzern/Bern via ABO
v. u. n. Aarau

Gleise
351
352

+	OLTEN PB		37.30
+		5.86	
+	Rothrist		31.44
+		19.39	
+	Wanzwil (Abzw)		12.05
+	Inkwil (Verzw)	6.56	
+	Subingen		5.49
+		2.45	
+	Derendingen		3.04
+	SOLOTHURN	3.04	0.00

v. u. n. Aarau
v. u. n. Basel

OLTEN

+			
+	Olten Hammer	1.33	60.07
+		2.42	58.74
+	Wangen bei Olten		56.32
+	Hägendorf	2.26	54.06
+		2.14	
+	Härkingen Paketpost		51.92
+	Egerkingen	1.66	50.26
+	Oberbuchsiten	2.32	47.94
+	v. u. n. Balsthal	5.21	
+	Oensingen		42.73
+	Niederbipp	1.98	40.75
+		5.69	
+	Wangen a.d. Aare		35.06
+		3.30	
+	Deitingen		31.76
+		2.75	
+	Luterbach-Attisholz		29.01
+	v. u. n. Wanzwil	3.46	
+	SOLOTHURN		25.55
+		0.96	
+	Solothurn West v. u. n. Moutier Solothurn Allmend	0.88	24.59
+	Bellach	2.00	21.71
+	Selzach	3.04	18.67
+		2.19	
+	Bettlach		16.48
+	Grenchen Süd v. u. n. Moutier	2.39	14.09
+	Lengnau	2.72	11.37
+	Pieterlen	2.22	9.15
+		1.98	
+	Biel/Bienne Bözingenfeld/ Champs-de-Boujean	1.78	7.17
+	Biel Mett (Abzw)	1.83	5.39
+	Biel Mett	0.44	3.56
+	BIEL PB	3.12	3.12
+			0.00

v. u. n. Neuchâtel

Biel Mett Abzw.

BIEL RB

SOLOTHURN

v. u. n. Zollikofen

v. u. n. Bern

BIEL PB

Km	Km
Entf. von Stat. zu Stat.	Entf. vom Ausgangspunkt

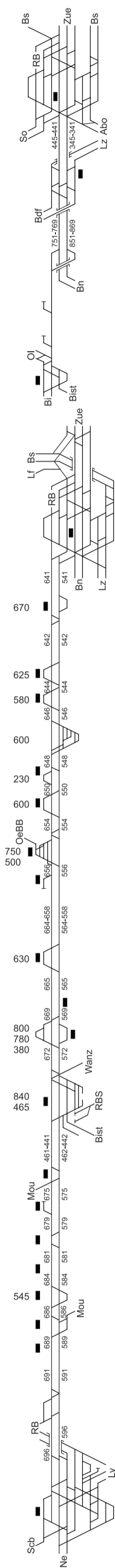
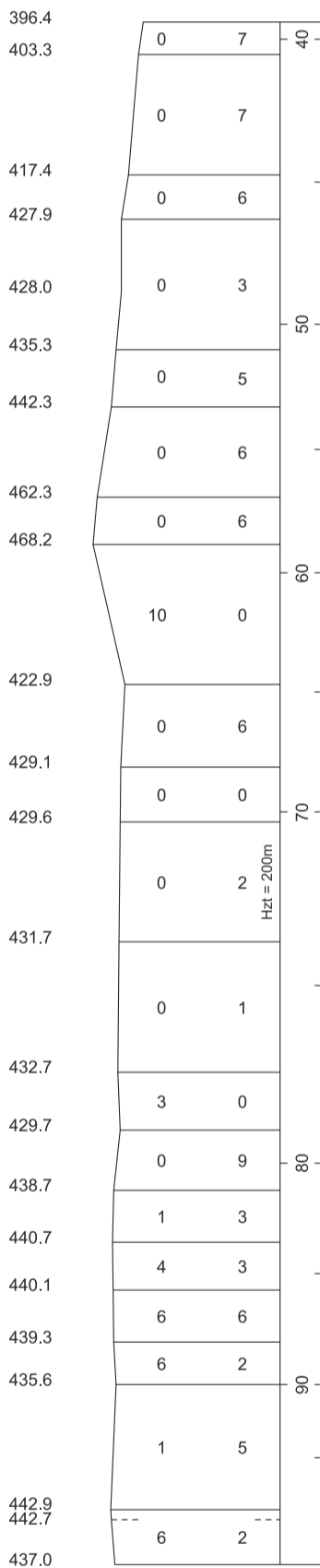



I-FN-FPA-RME

Ausgabe von 15.12.2013

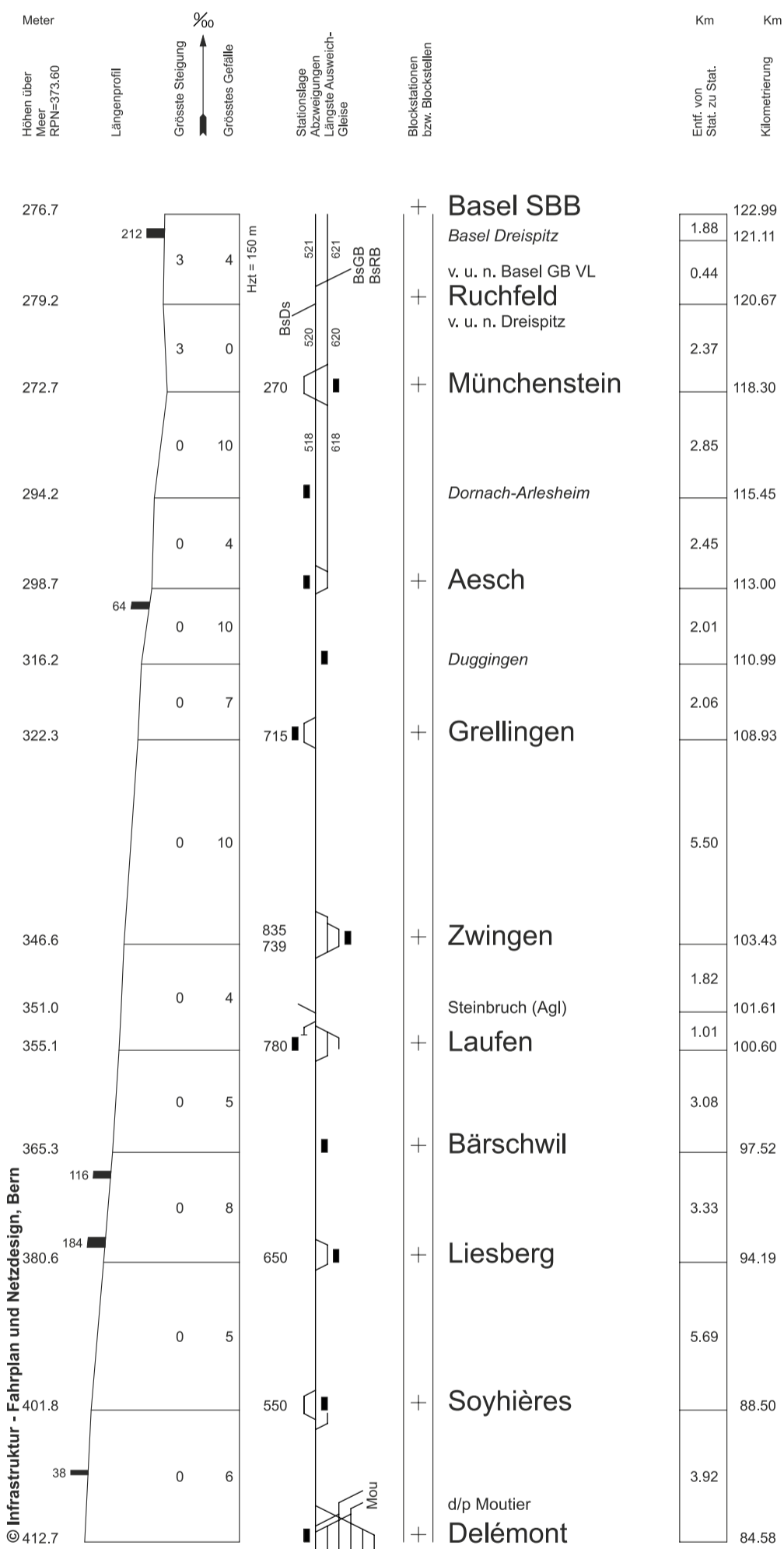

d/p Porrentruy

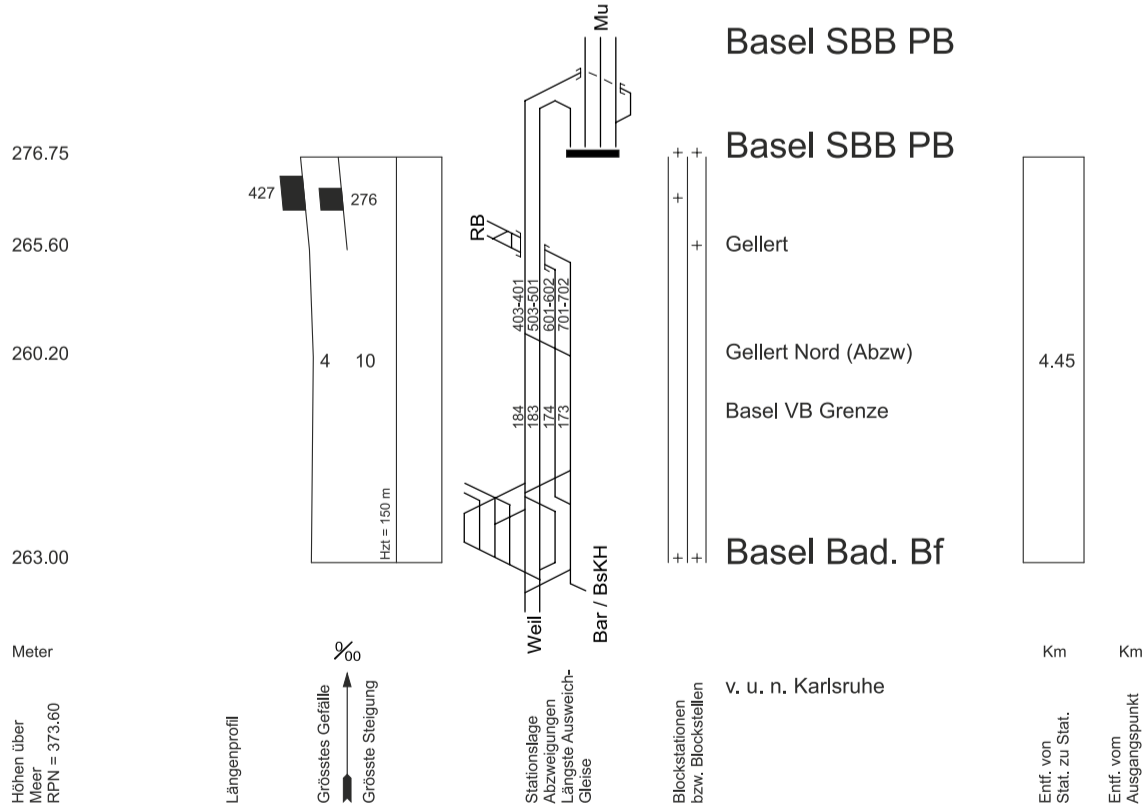
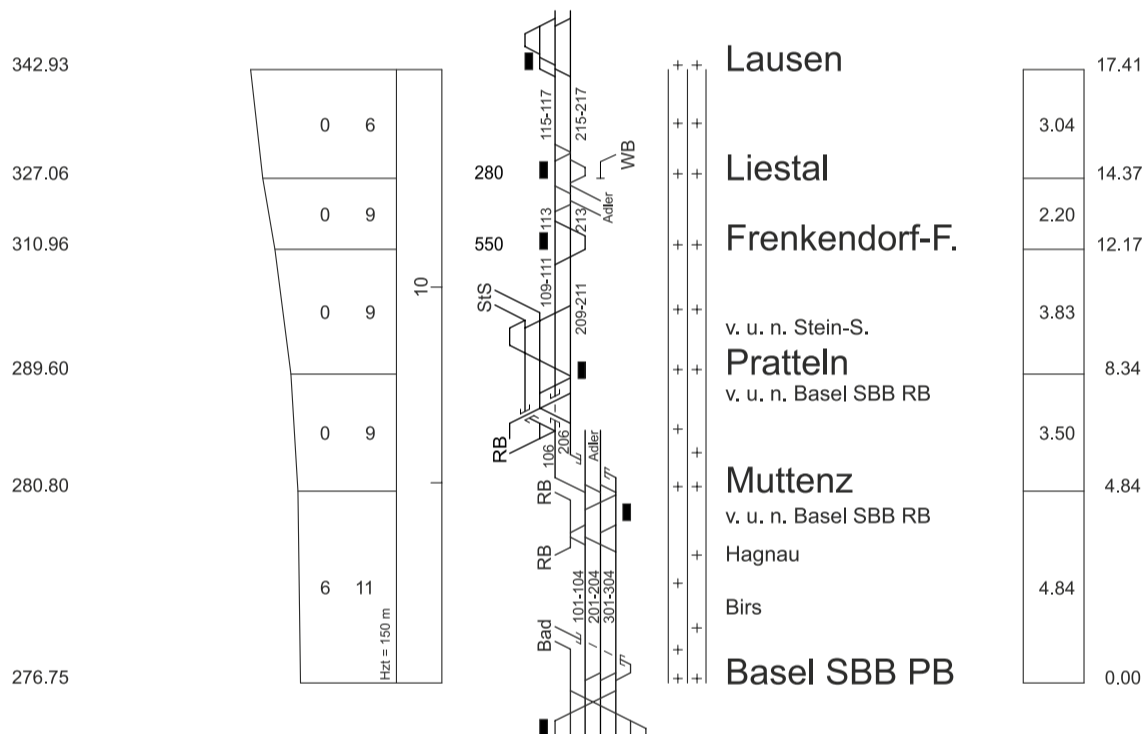
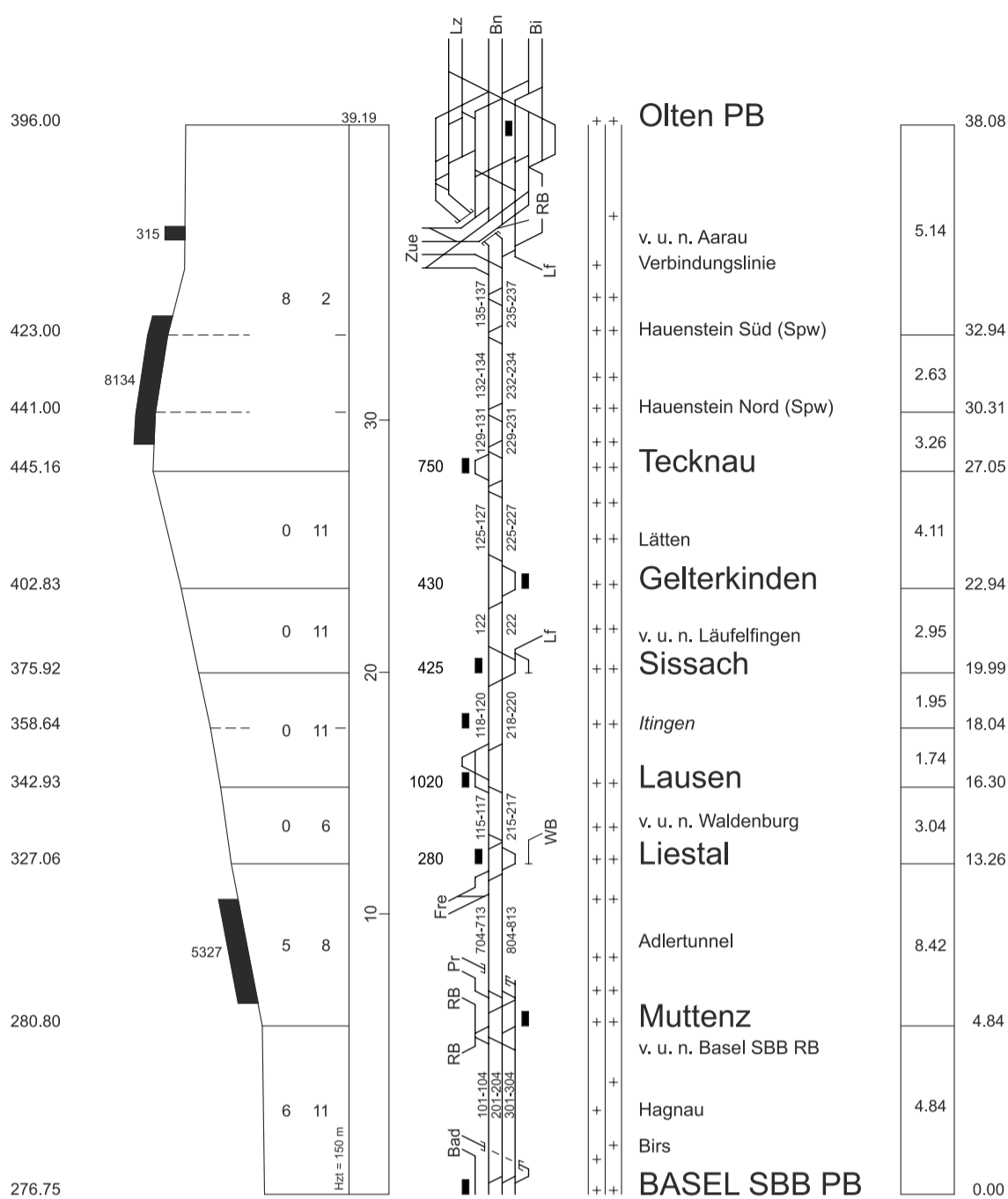

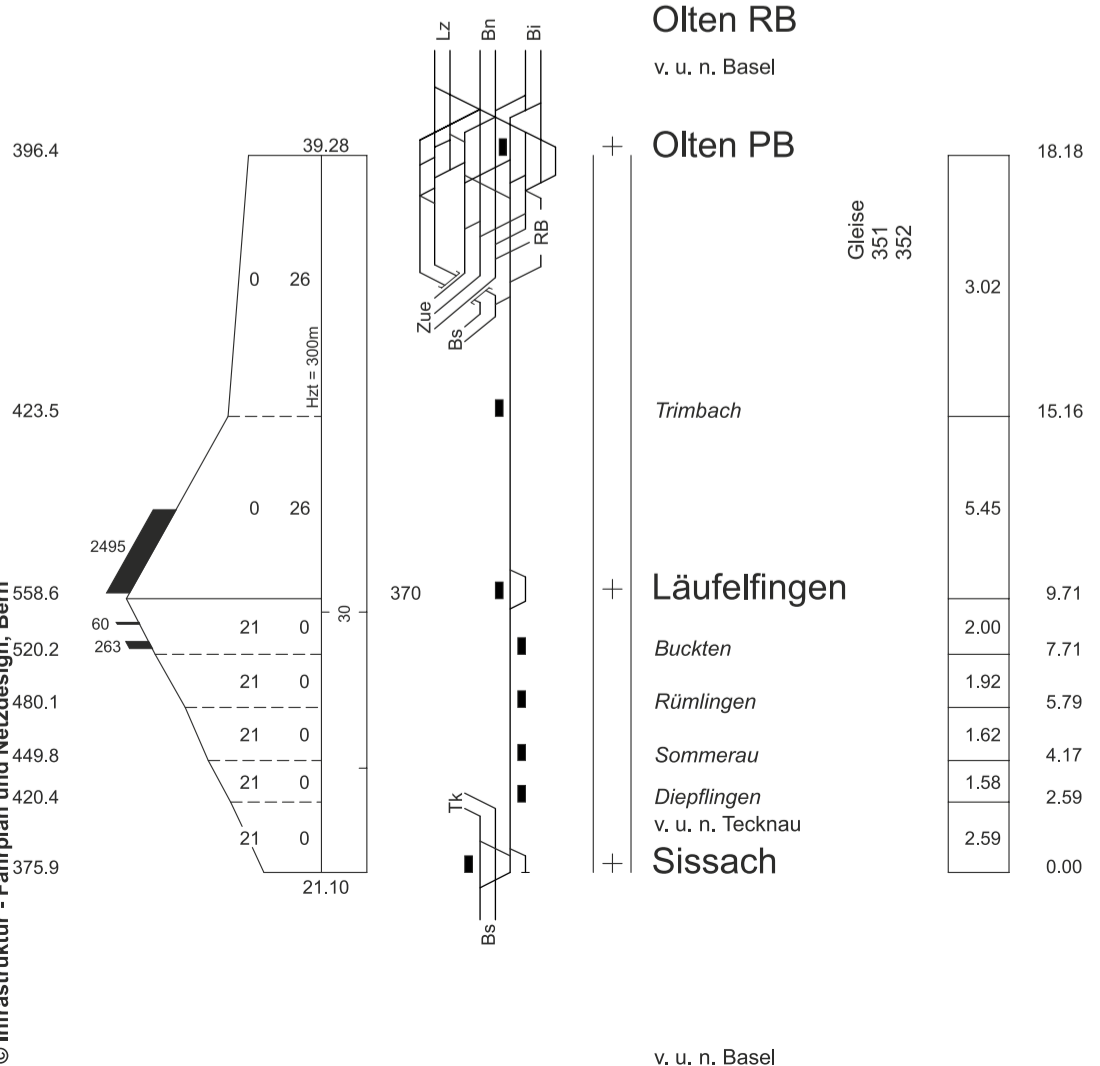
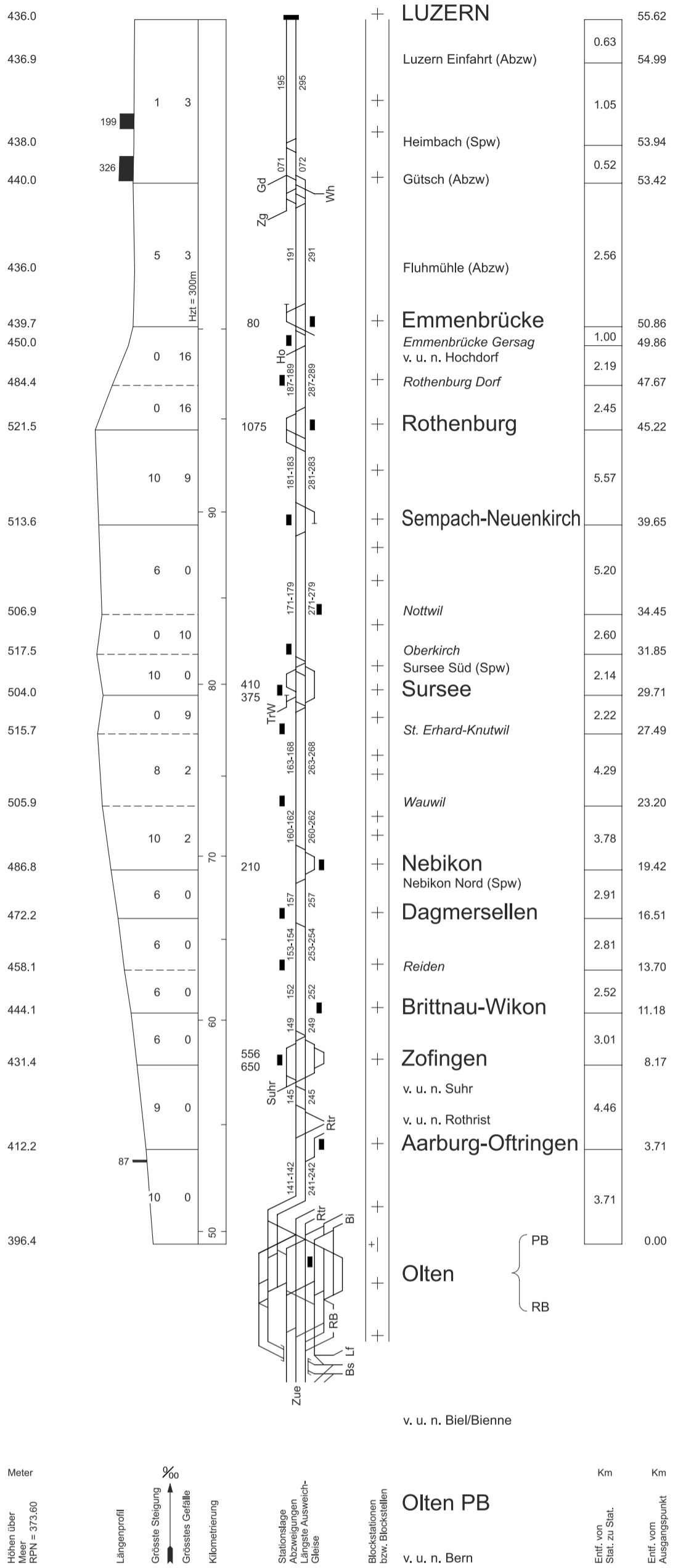

v. u. n. Brünig

LUZERN

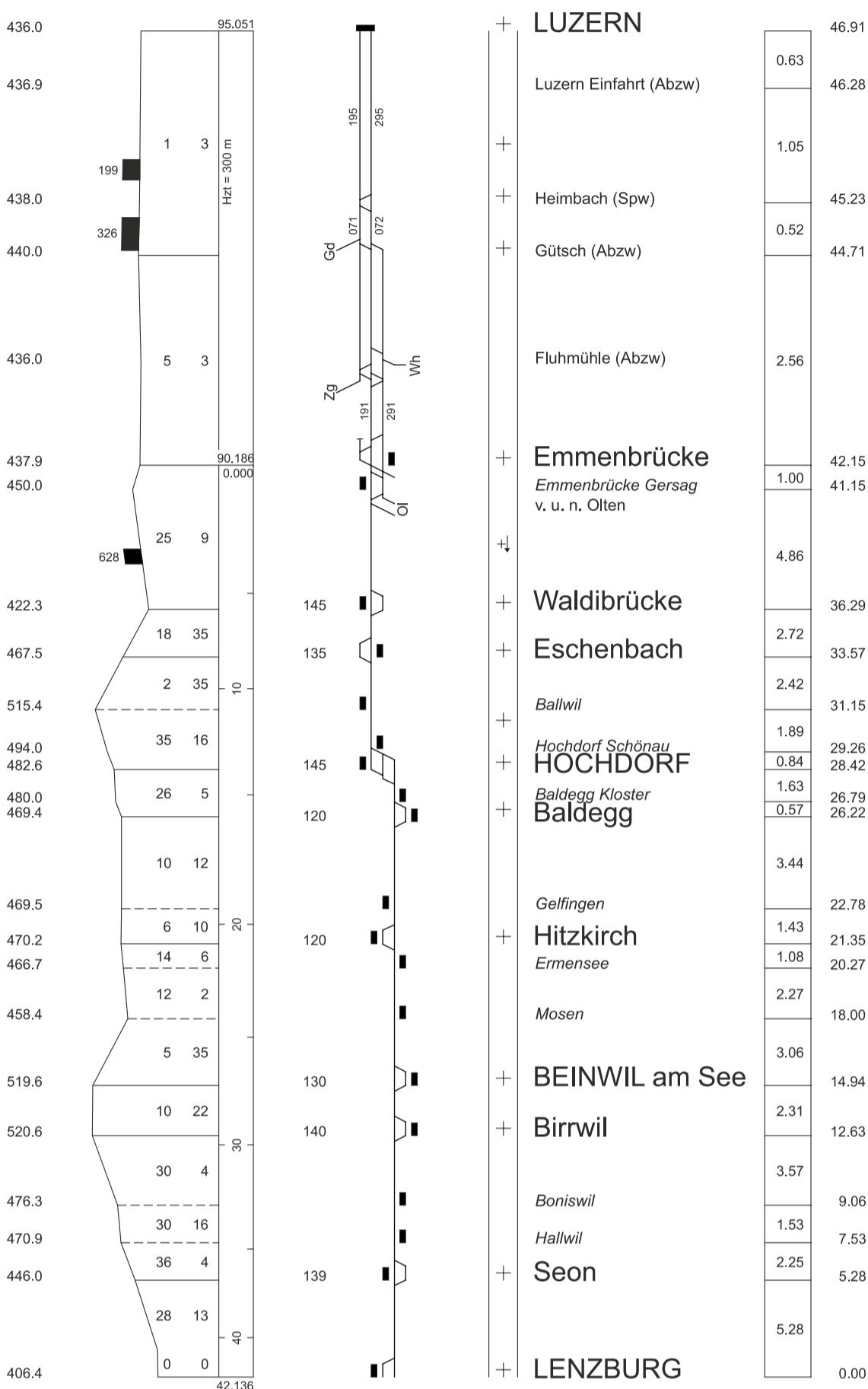

Meter
Höhen über Meer
RPN = 373.60

Längenprofil
Grösste Steigung
Grösstes Gefälle
Kilometrierung

Stationslage
Abzweigungen
Längste Ausweichgleise

Blockstationen bzw. Blockstellen

Km
Entf. von Stat. zu Stat.
Entf. vom Ausgangspunkt

Henschiken

Gexi

LENZBURG

Rupperswil

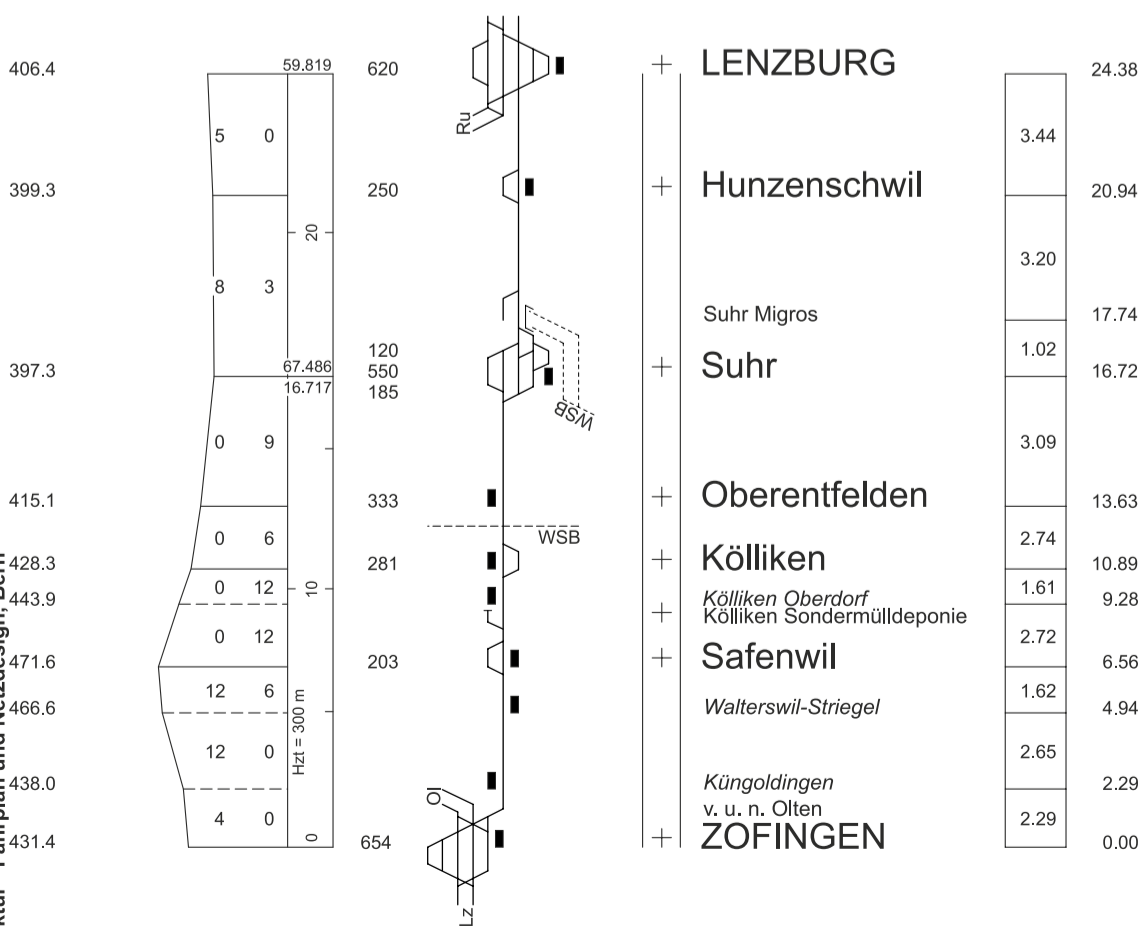

v. u. n. Luzern

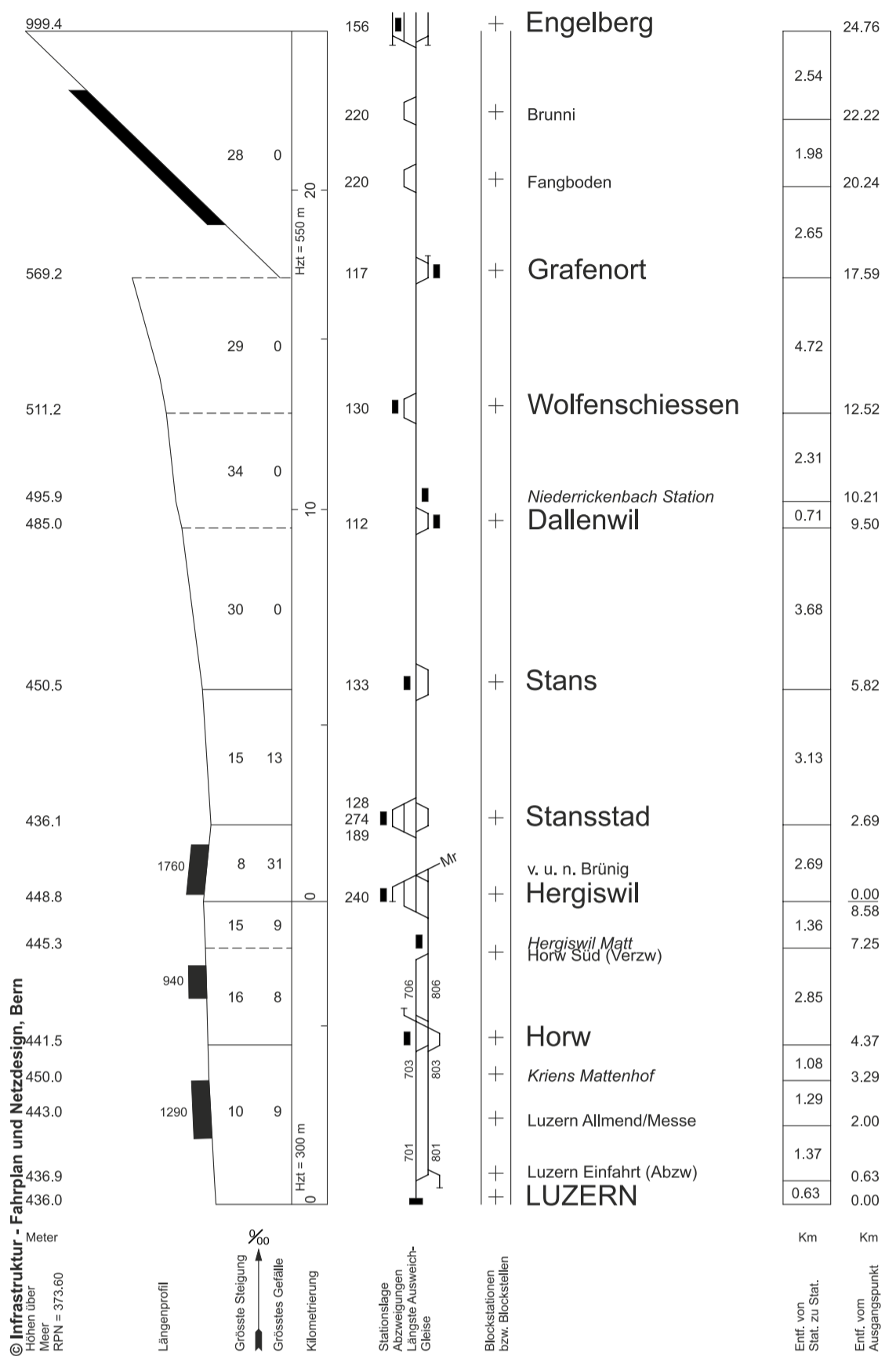

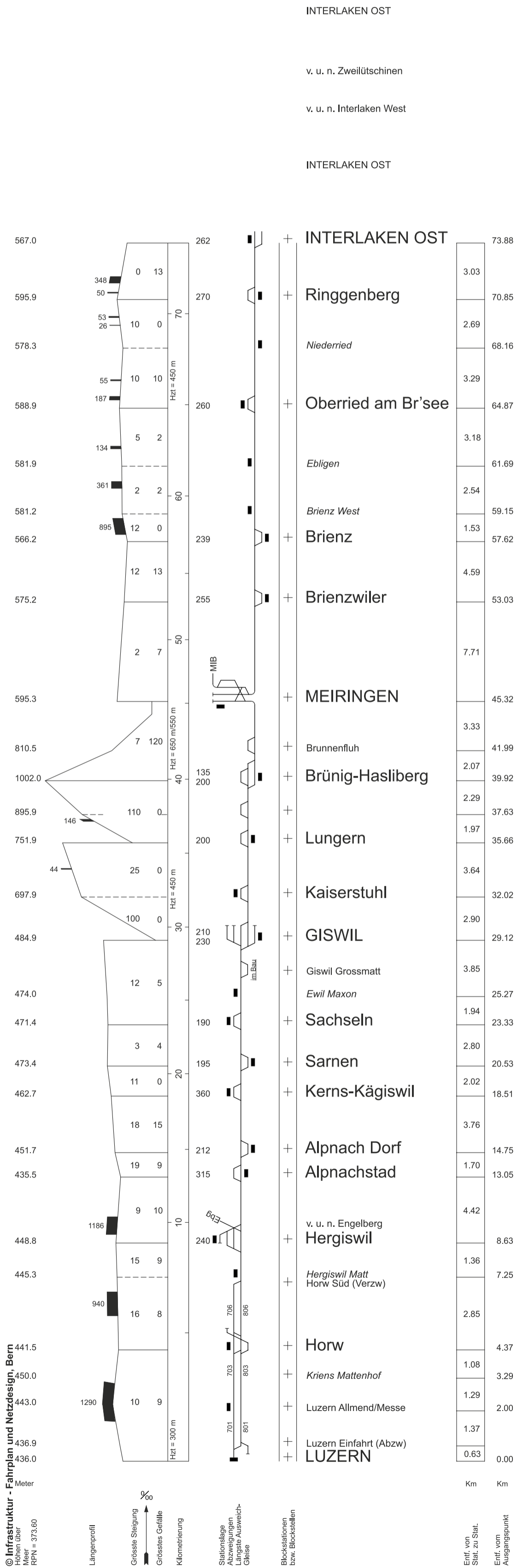

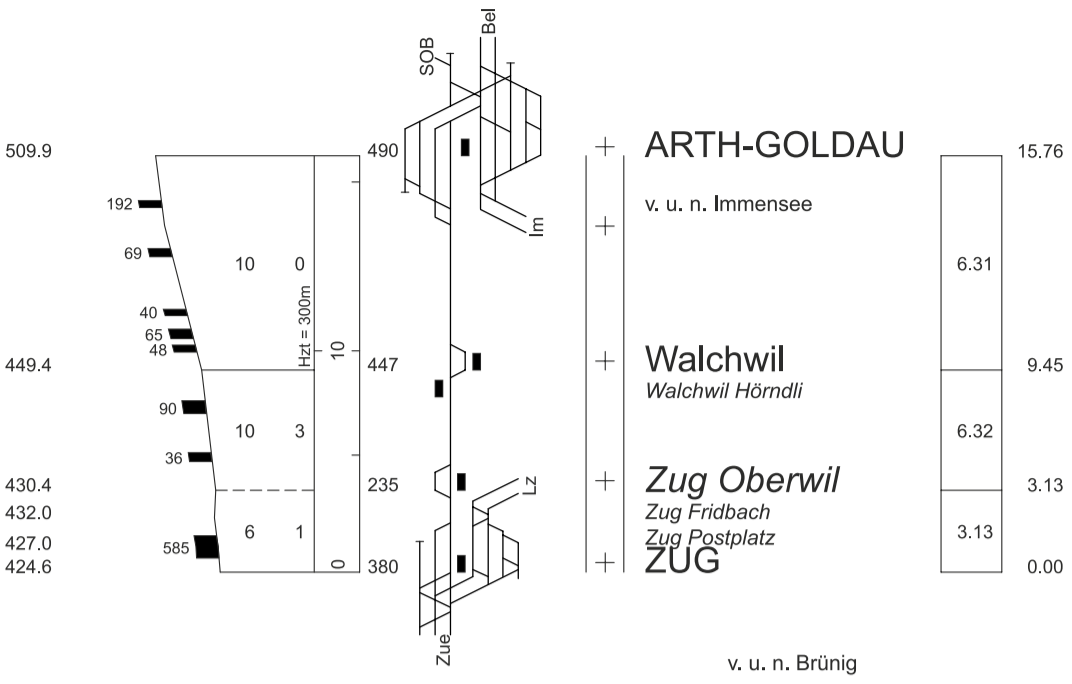

v. u. n. Brünig

LUZERN

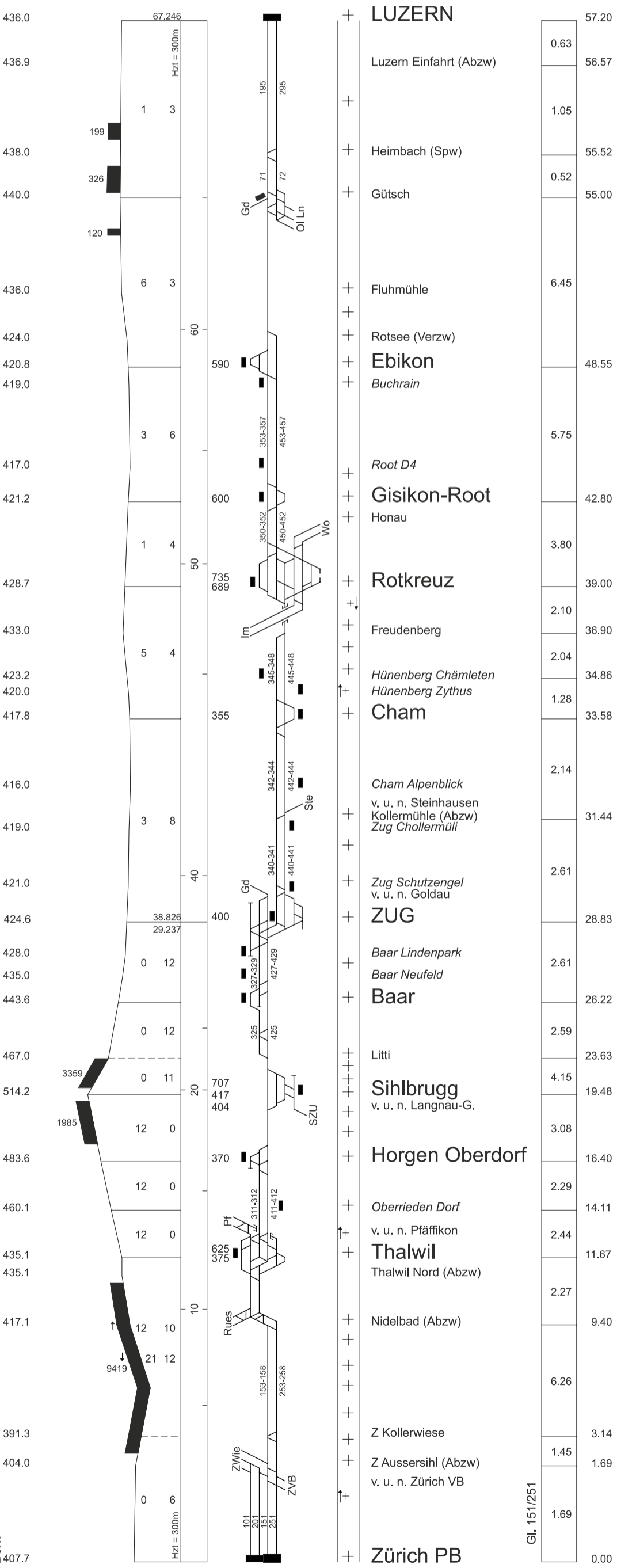

Gl. 151/251

Zch Aussersihl

Zch Vorbahnhof

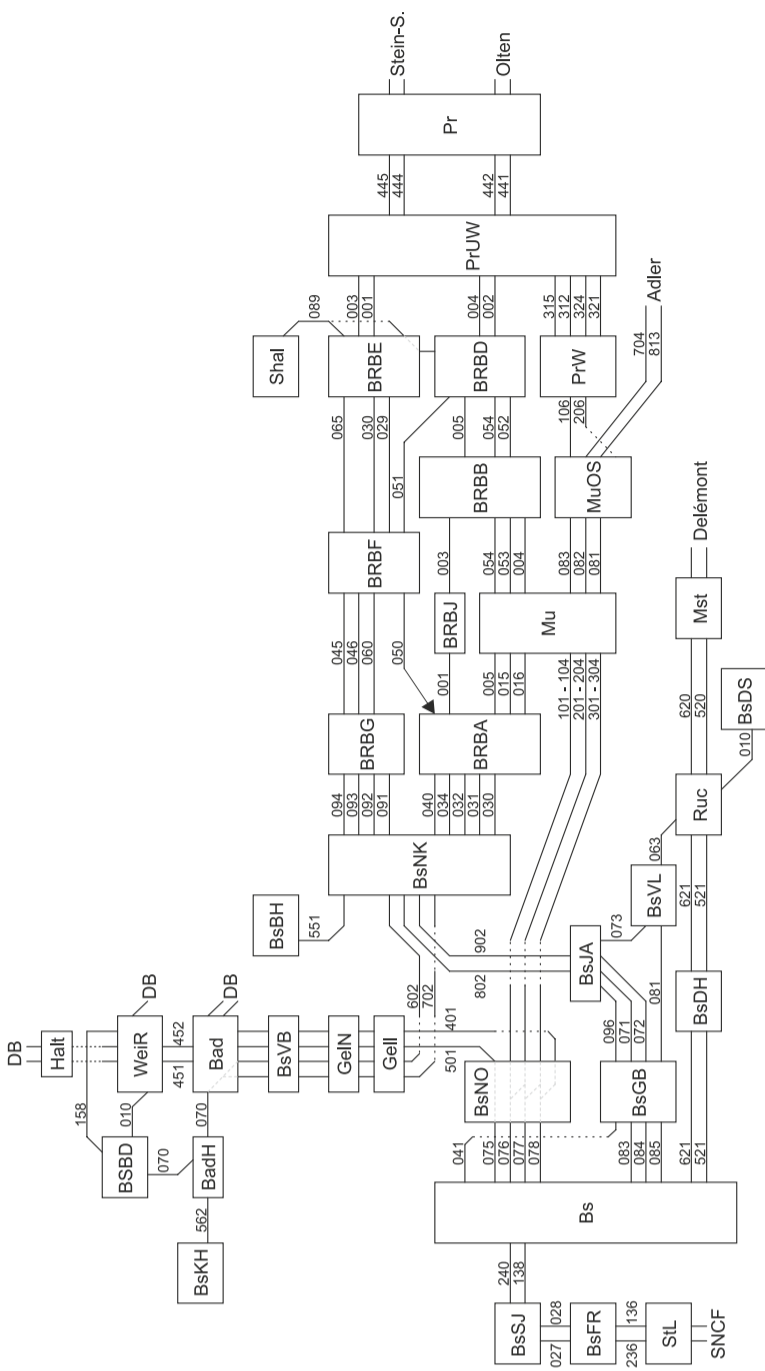

v. u. n. Olten

+ Pratteln

v. u. n. Schweizerhalle

+ Basel RB Gr E

+ Basel RB Gr F
v. u. n Gr A

+ Basel RB Gr G

Nordkopf

+ Gellert

Gellert Nord (Abzw)

+ Basel Bad. Bf.

+ Weil (Rhein)

+ Basel Bad. Rbf.

+ Basel Bad. Bf.

+ Basel Bad Rbf Kleinh. Abzw.

+ Basel Bad. Rbf.

+ Basel Bad. Bf.

+ Basel Bad Rbf Kleinh. Abzw.

+ Basel Kleinh. Hafen

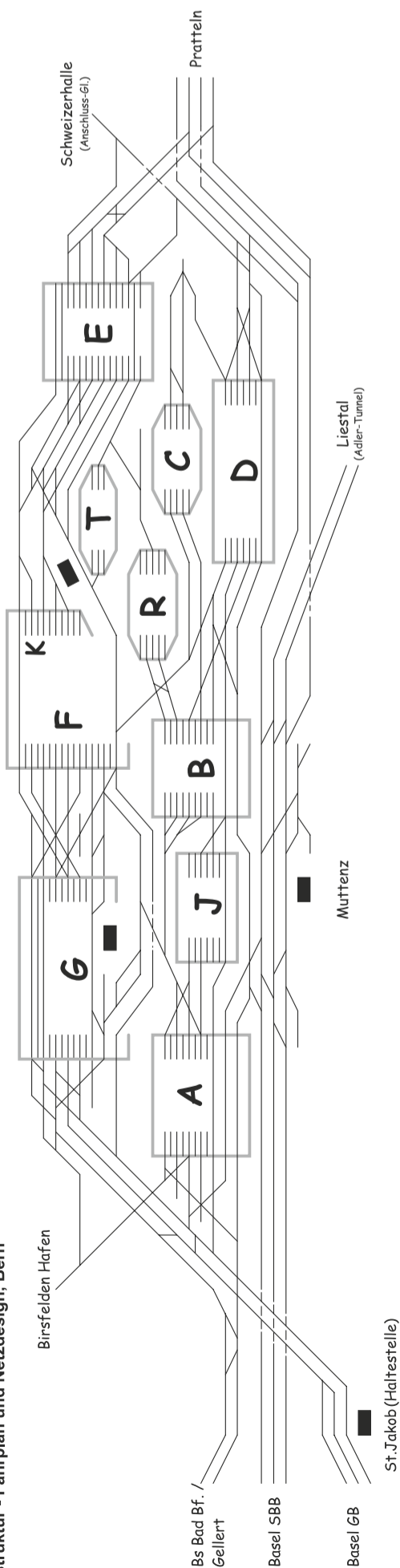

v. u. n. Stein-S.

+ Pratteln

+ Basel RB Gr D

Basel RB Gr B

+ Muttenz

+ Basel RB Gr A

Nordkopf

Basel St. Jakob

+ Basel SBB GB
v. u. n. Basel SBB (GI 041)

+ Basel SBB PB

+ Basel St. Johann

+ Saint-Louis

+ Basel RB Gr A

v. u. n. Gr G

Nordkopf

+ Birsfelden Hafen



I-FN-FPA-RME

Ausgabe von 15.12.2013

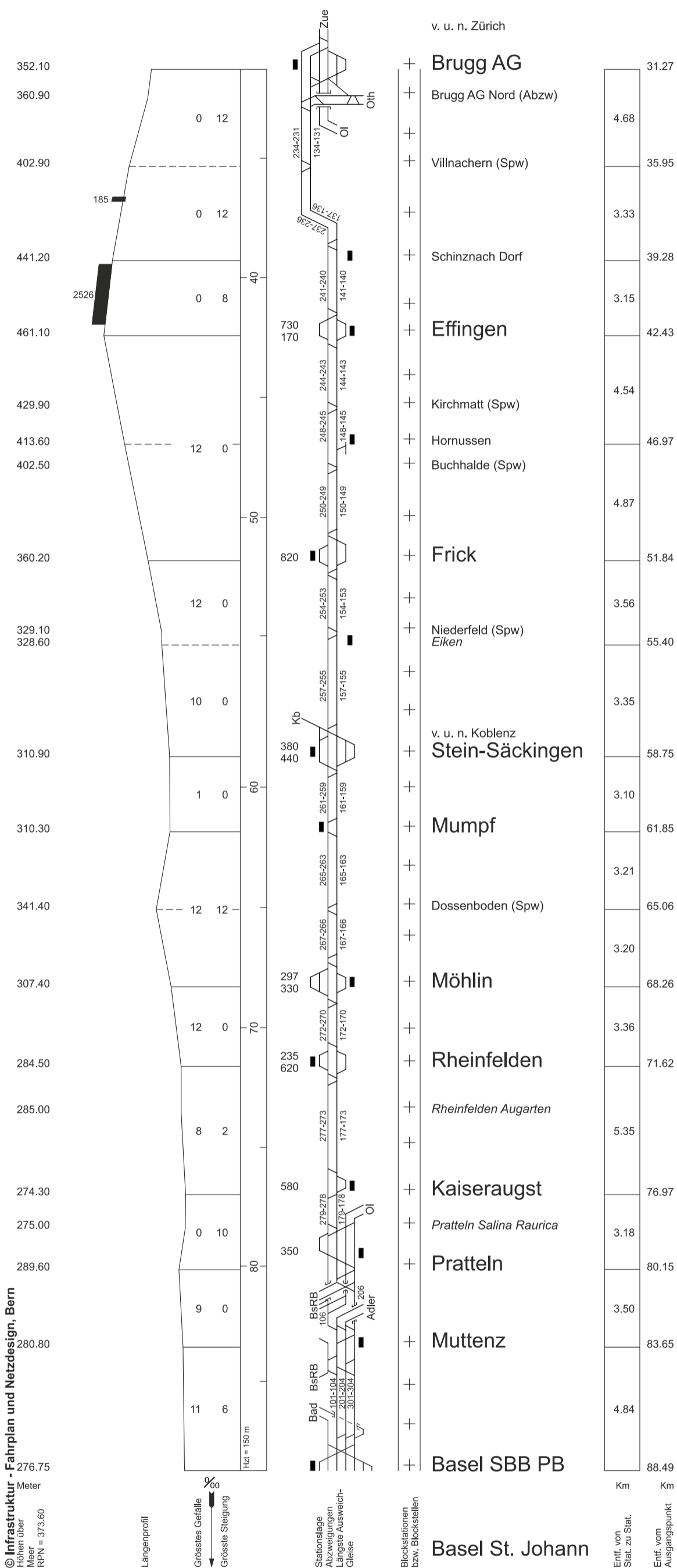

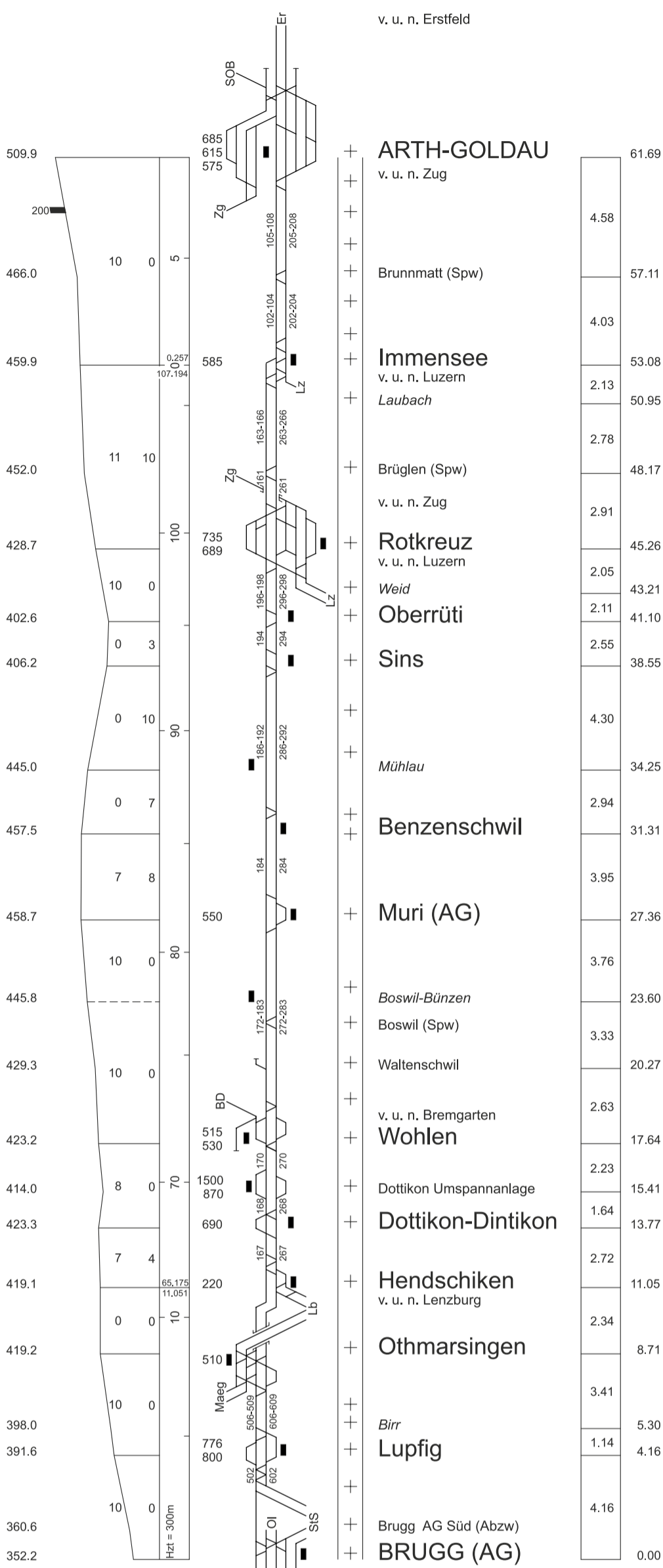

Höhen über Meer = 373.60
RPN = 373.60

Längenprofil

Grösste Steigung ‰
Grösstes Gefälle

Kilometrierung

Stationslage
Abzweigungen
Längste Ausweichgleise

Blockstationen bzw. Blockstellen

BRUGG (AG)

Entf. von Stat. zu Stat. Entf. vom Ausgangspunkt

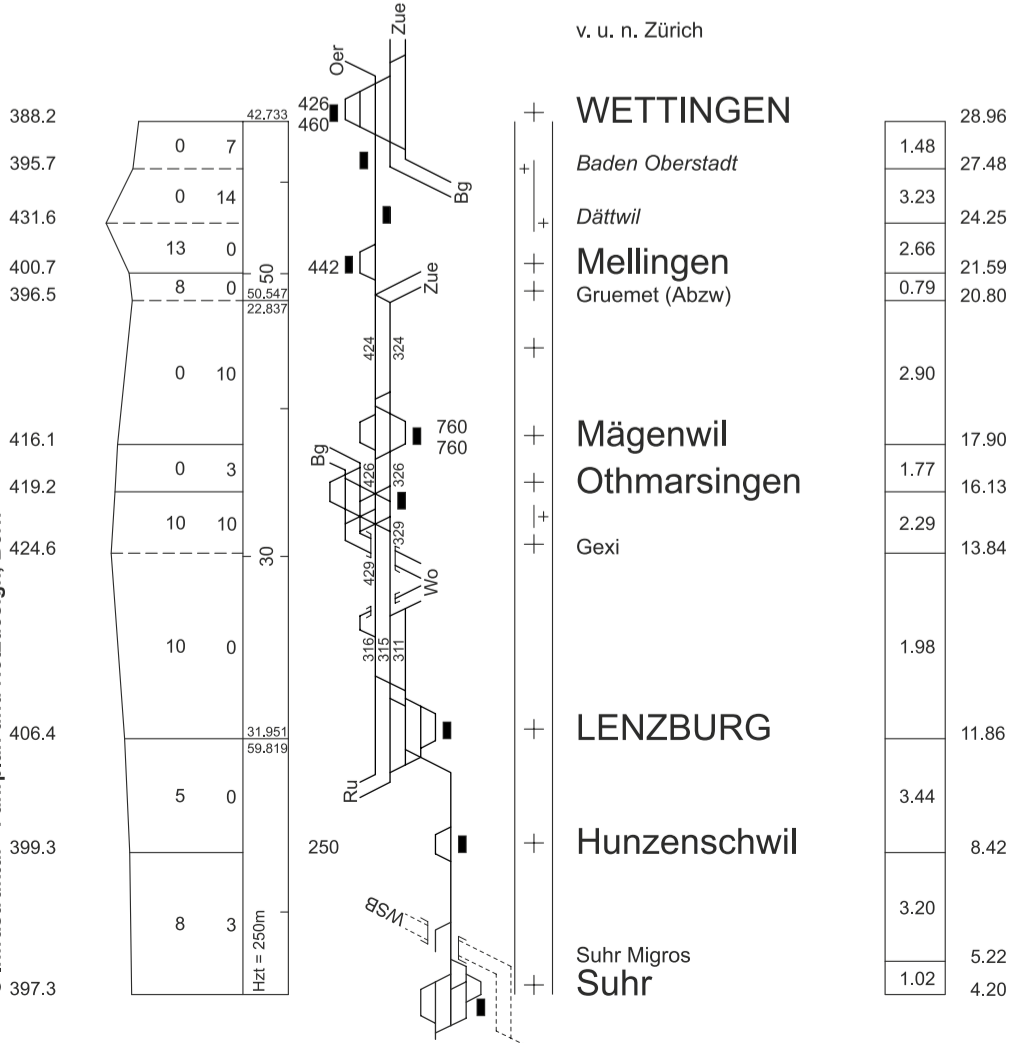

v. u. n. Zürich

WETTINGEN

Entf. von Stat. zu Stat. Entf. vom Ausgangspunkt

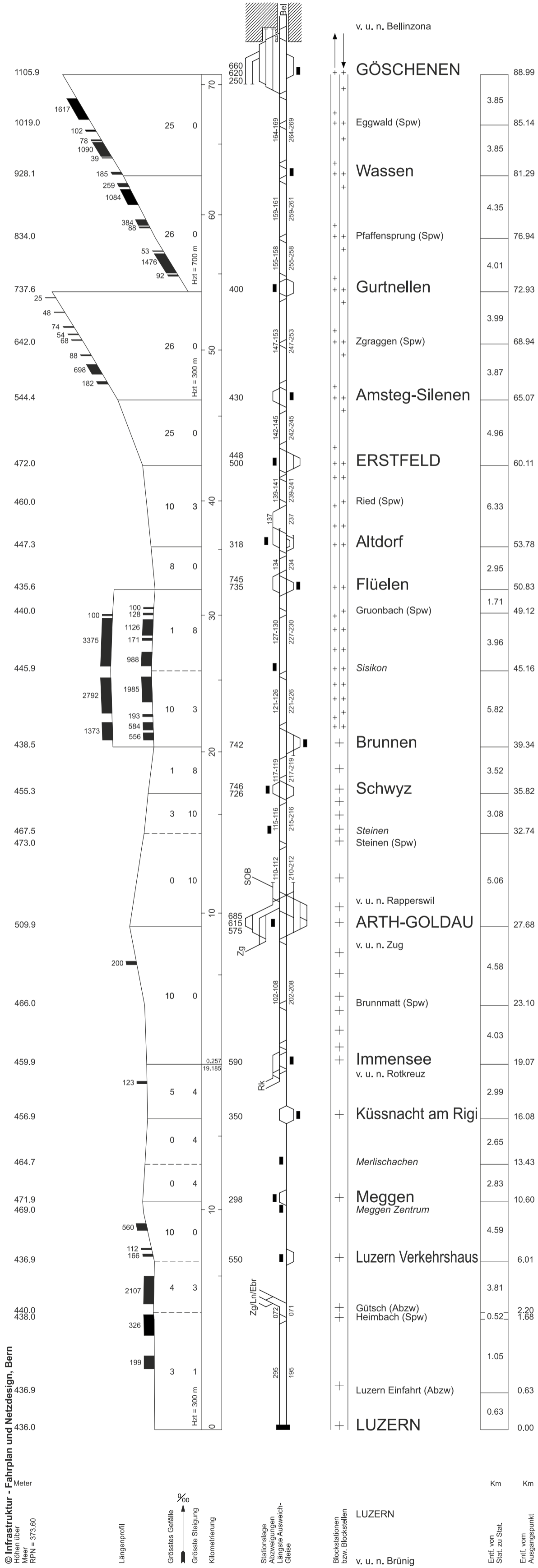

© Infrastruktur - Fahrplan und Netzdesign, Bern
 Höhen über Meer
 RPN = 373.60



I-FN-FPA-RME

Edizione 15.12.2013

da e per Como

Chiasso

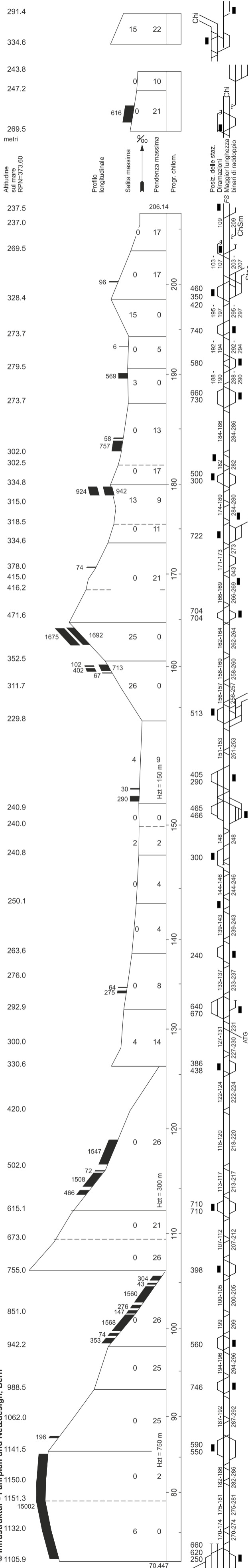

+	Lugano Vedeggio	107.34
+	Taverne-Torricella	3.79
+	Chiasso SM	135.61
+	Balerna	133.06
+	Chiasso	135.67
+	Balerna	133.06
+	Mendrisio	128.24
++	Mendrisio S. Martino	4.10
++	Capolago-R.S.V.	124.14
++	Maroggia-Melano	120.56
++	Melide	116.75
++	Lugano Paradiso (c bin) Lugano Paradiso	112.74 112.37
++	Lugano	109.98
++	Lamone (c bin)	107.40
++	Lamone-Cadempino da e per Lugano Vedeggio	105.63
++	Taverne-Torricella	103.55
++	Sigirino	100.85
++	Mezzovico (c bin) Mezzovico	99.55 98.38
++	Rivera-Bironico	94.74
++	Al Motto (c bin)	90.92
++	Vigana (c bin) da e per Luino/Locarno	87.57
++	Giubiasco	93.57
++	Bellinzona Sud	80.42
++	Bellinzona	79.29
++	Bellinzona Collegamento S. Paolo	1.13
++	Bellinzona Nord (bif)	2.50
++	Castione-Arbedo	76.79
++	Claro	73.00
++	Osogna-Cresciano	67.49
++	Giustizia (dira)	6.17
++	Biasca	61.32
++	Pollegio Nord	6.29
++	Bodio	55.03
++	Giornico (c bin)	50.66
++	Pianotondo (c bin)	46.96
++	Lavorgo	42.12
++	Chiggiona (c bin)	38.93
++	Faido	35.57
++	Pardorea (c bin)	31.47
++	Rodi-Fiesso	27.37
++	Ambri-Piotta	22.58
++	Sordo (c bin)	19.21
++	Airolo	15.74
++	Gottardo Sud (c bin)	10.85
++	Gotthard Nord (Spw)	4.90
++	Göschenen	0.00

v. u. n. Erstfeld

55



FFS

I-FN-FPA-RME

Edizione 15.12.2013

da e per Domodossola

Locarno

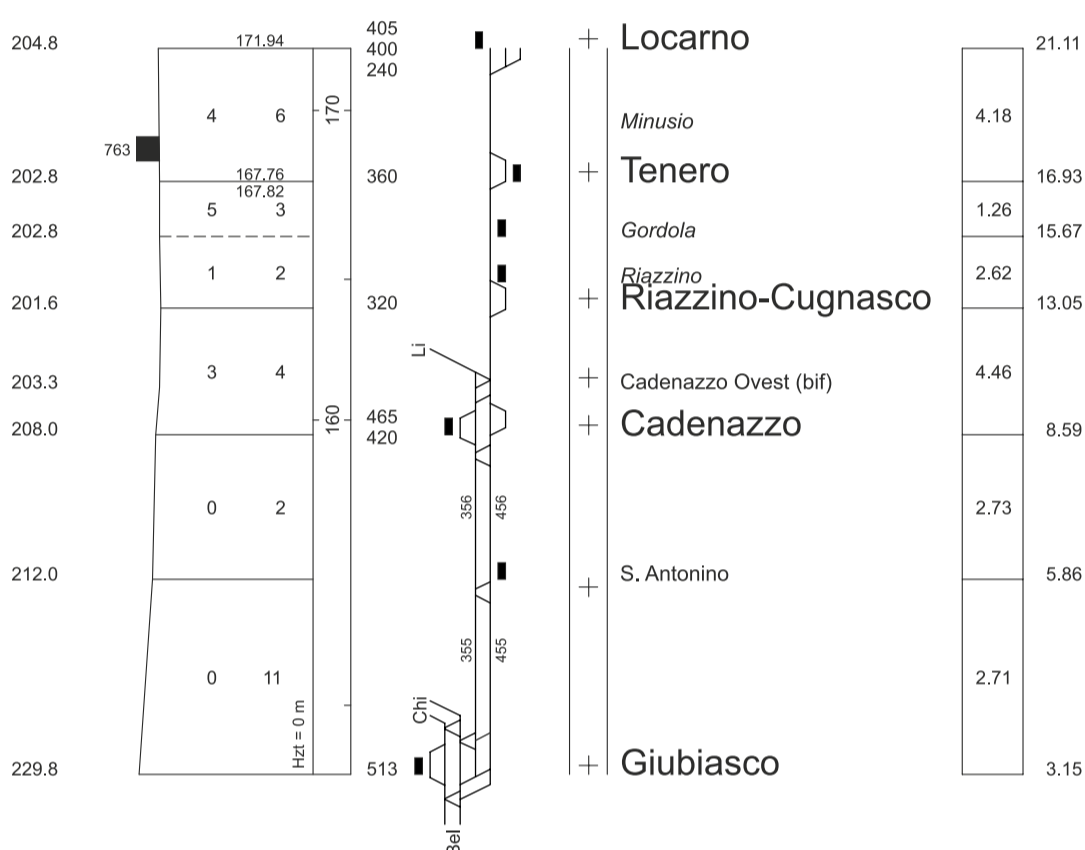

© Infrastruktur - Fahrplan und Netzdesign, Bern

metri
Alitudine
sull mare
RPN=373.60

Profilo
longitudinale

Salita massima
Pendenza massima
%
↑

Progr. chilom.

Posiz. delle staz.
Diramazioni
Maggior lunghezza
binari di raddoppio

Staz. di blocco
risp. posti di blocco

Km

Km

da e per Airolo

S. Paolo

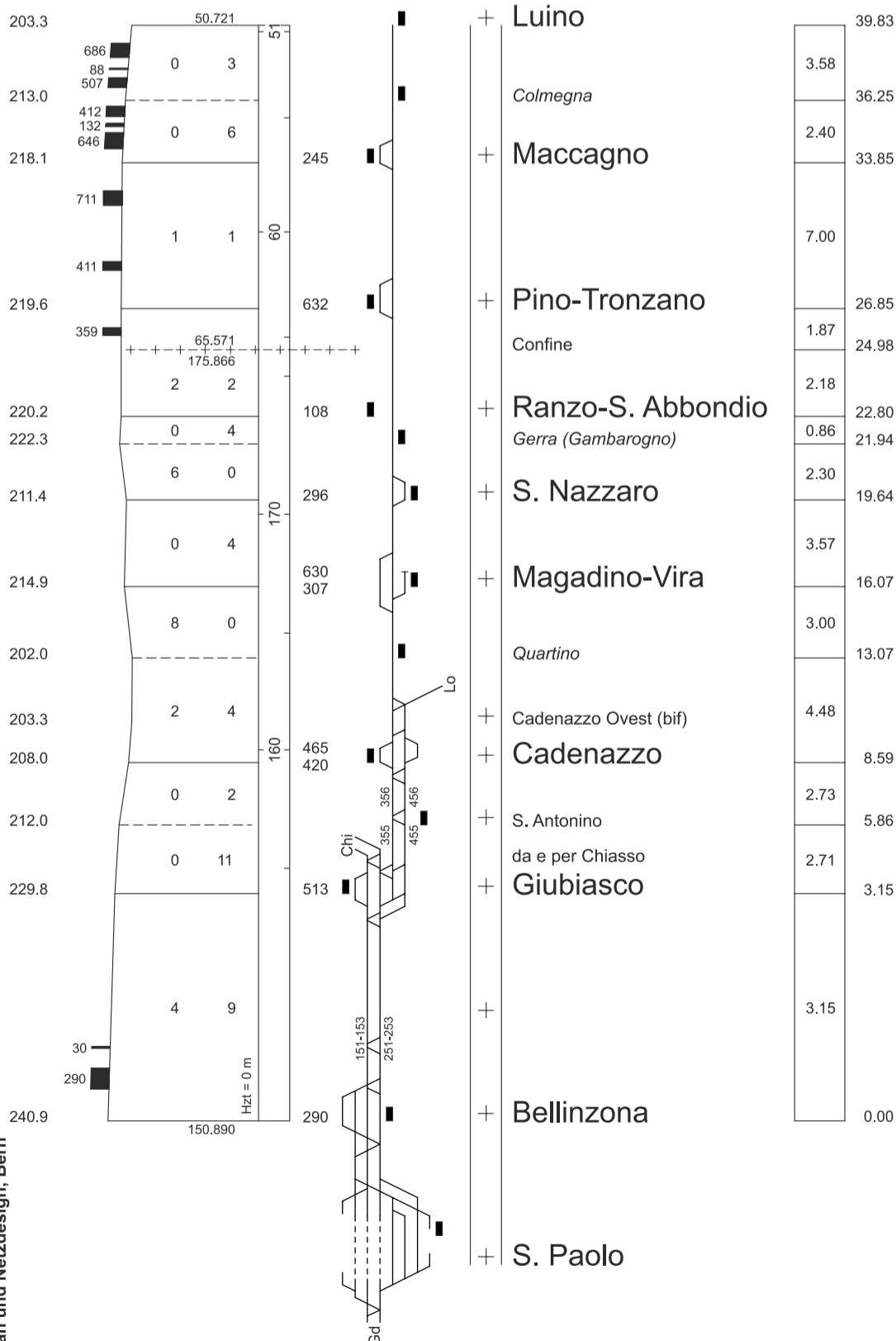



SBB 16 A

I-FN-FPA-ROT

Ausgabe von 15.12.2013

Mellingen Heitersberg

v/n Lenzburg

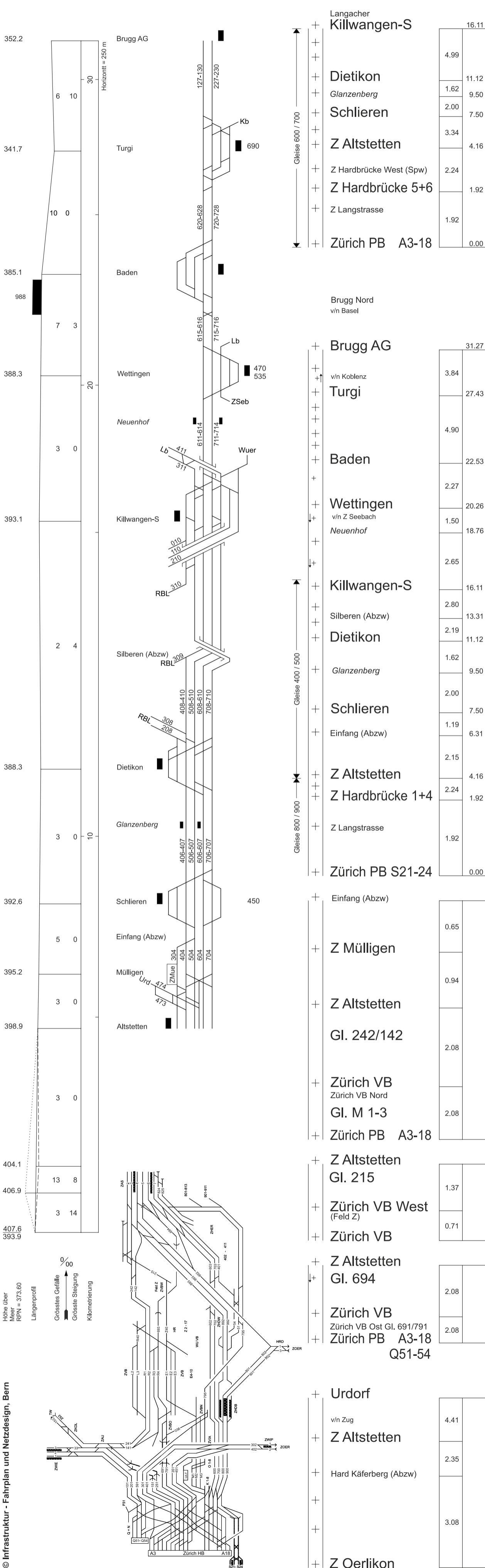

Höhe über Meer
RPN = 373.60

Langenprofil

Grösstes Gefälle
Grösste Steigung
Kilometrierung

© Infrastruktur - Fahrplan und Netzdesign, Bern

Gleise 600 / 700

Gleise 400 / 500

Gleise 800 / 900

Langacher		
Killwangen-S	4.99	16.11
Dietikon		11.12
Glanzenberg	1.62	9.50
Schlieren	2.00	7.50
Z Altstetten	3.34	4.16
Z Hardbrücke West (Spw)	2.24	
Z Hardbrücke 5+6		1.92
Z Langstrasse	1.92	
Zürich PB A3-18		0.00

Brugg Nord		
v/n Basel		
Brugg AG		31.27
v/n Koblenz	3.84	
Turgi		27.43
Baden	4.90	
Wettingen		22.53
v/n Z Seebach	2.27	
Neuenhof		20.26
Killwangen-S	1.50	
Silbernen (Abzw)		18.76
Dietikon	2.65	
Glanzenberg		16.11
Schlieren	2.80	
Einfang (Abzw)		13.31
Z Altstetten	2.19	
Z Hardbrücke 1+4		11.12
Z Langstrasse	1.62	
Zürich PB S21-24		9.50
Einfang (Abzw)	2.00	
Z Mülligen		7.50
Z Altstetten	1.19	
Gl. 242/142		6.31
Zürich VB	2.15	
Zürich VB Nord		4.16
Gl. M 1-3		2.24
Zürich PB A3-18		1.92
Z Altstetten		
Gl. 694		
Zürich VB		
Zürich VB Ost Gl. 691/791		
Zürich PB A3-18		
Q51-54		
Urdorf		
v/n Zug		
Z Altstetten		
Hard Käferberg (Abzw)		
Z Oerlikon		

Einfang (Abzw)		0.65
Z Mülligen		0.94
Z Altstetten		2.08
Gl. 242/142		2.08
Zürich VB		2.08
Zürich VB Nord		1.37
Gl. M 1-3		0.71
Zürich PB A3-18		
Z Altstetten		
Gl. 215		
Zürich VB West (Feld Z)		
Zürich VB		
Z Altstetten		
Gl. 694		
Zürich VB		
Zürich VB Ost Gl. 691/791		
Zürich PB A3-18		
Q51-54		

Einfang (Abzw)		0.65
Z Mülligen		0.94
Z Altstetten		2.08
Gl. 242/142		2.08
Zürich VB		2.08
Zürich VB Nord		1.37
Gl. M 1-3		0.71
Zürich PB A3-18		
Z Altstetten		
Gl. 215		
Zürich VB West (Feld Z)		
Zürich VB		
Z Altstetten		
Gl. 694		
Zürich VB		
Zürich VB Ost Gl. 691/791		
Zürich PB A3-18		
Q51-54		

Urdorf		4.41
v/n Zug		
Z Altstetten		2.35
Hard Käferberg (Abzw)		
Z Oerlikon		3.08



I-FN-FPA-ROT

Ausgabe von 15.12.2013

Höhen über Meer
RPN = 373.60

Längenprofil

Grösstes Gefälle
Grösste Steigung

Kilometrierung

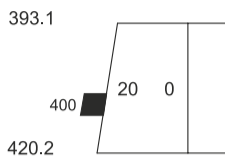

Stationsanlage

Abzweigungen

Längste Ausweichgleise

Blockstationen

Baden Oberstadt

v/n Lenzburg

Wettingen

Entfernung von Stat. zu Stat.

Entfernung vom Ausgangspunkt

Killwangen-S.

2.35	
------	--

Würenlos

Baden

v/n Brugg

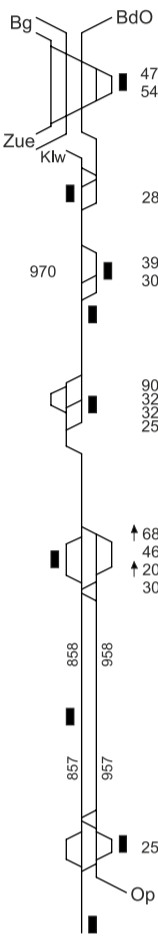
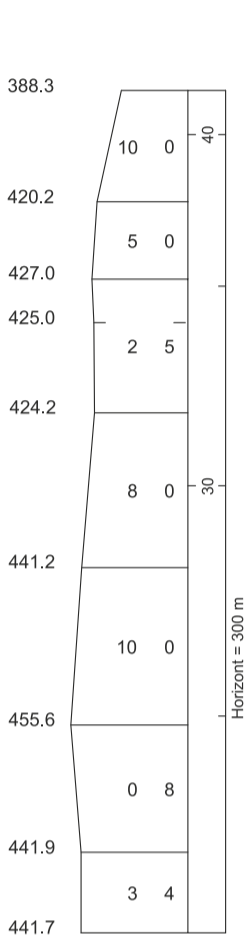

Wettingen

v/n Killwangen

Würenlos

Otelfingen

Otelfingen Industrie

Otelfingen Golfpark

Buchs-Dällikon

Regensdorf-Watt

Z Affoltern

Z Seebach

Z Oerlikon

0.00	
3.69	
3.69	
2.52	
6.21	
0.75	6.96
0.37	7.33
1.48	
8.81	
1.06	9.87
3.36	
13.23	
3.41	
16.64	
2.78	
19.42	
1.31	20.73

Z Affoltern

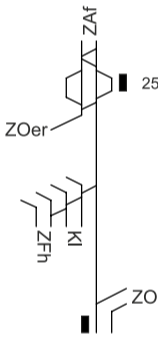
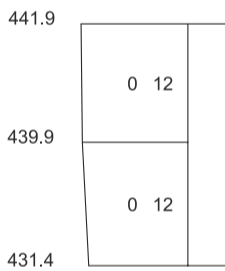

Z Seebach

Opfikon Süd

Glattbrugg

19.42	
1.10	20.52
0.90	21.42

v/n Bülach

Tankanlage Rümlang

Opfikon Süd

Opfikon

v/n Kloten

Riet

Z Altstetten

Z Herdern

Z Hardbrücke

Z Langstrasse

Zürich PB S21-24

Z Herdern

Zürich VB Nord

Gl. M1-3

Zürich PB A3-18 Q51-54

Zürich VB Nord

Gl. 591

Zürich PB A3-18 Q51-54

RBL 18

Ausgabe von 15.12.2013

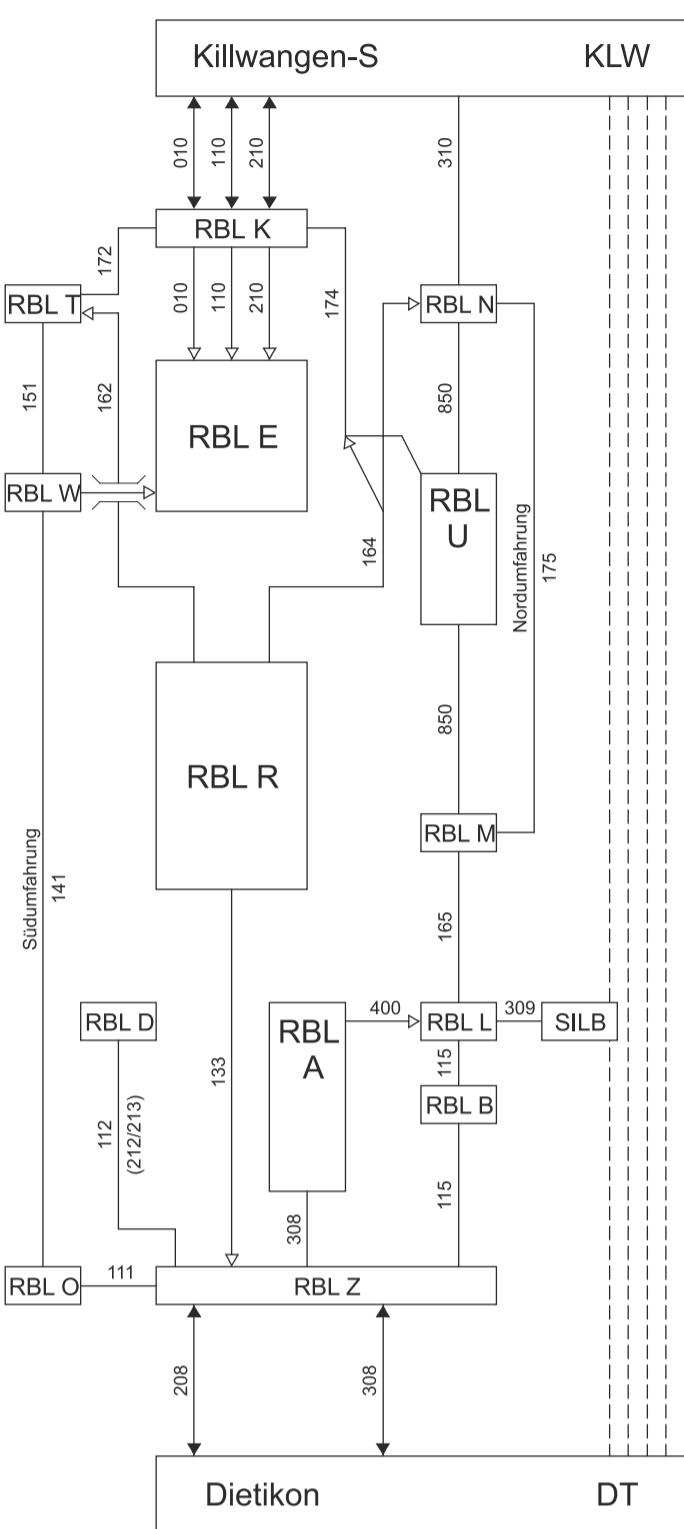

↔ Wechselbetrieb
 ⇨ Obligatorische Fahrrichtung

Mellingen-Heitersberg

v/n Lenzburg

Langacher Killwangen-S

Neuenhof

v/n Brugg

Killwangen-S

Würenlos

v/n Z Seebach

Killwangen-S

Killwangen-S

GI 010 / 110 / 210

RBL K

RBL E

RBL K

RBL U

RBL M

RBL L

RBL B

RBL Z

RBL K

RBL Tivoli

RBL West

Killwangen-S

GI 310

RBL N

RBL M

RBL L

Silberen

RBL L

RBL A

RBL Z

RBL N

RBL U

RBL N

RBL R

RBL Z

RBL D

RBL Z

RBL E

RBL West

RBL Ost

RBL Z

v/n Zürich

GI 208 / 308

Dietikon

© Infrastruktur - Fahrplan und Netzdesign, Bern

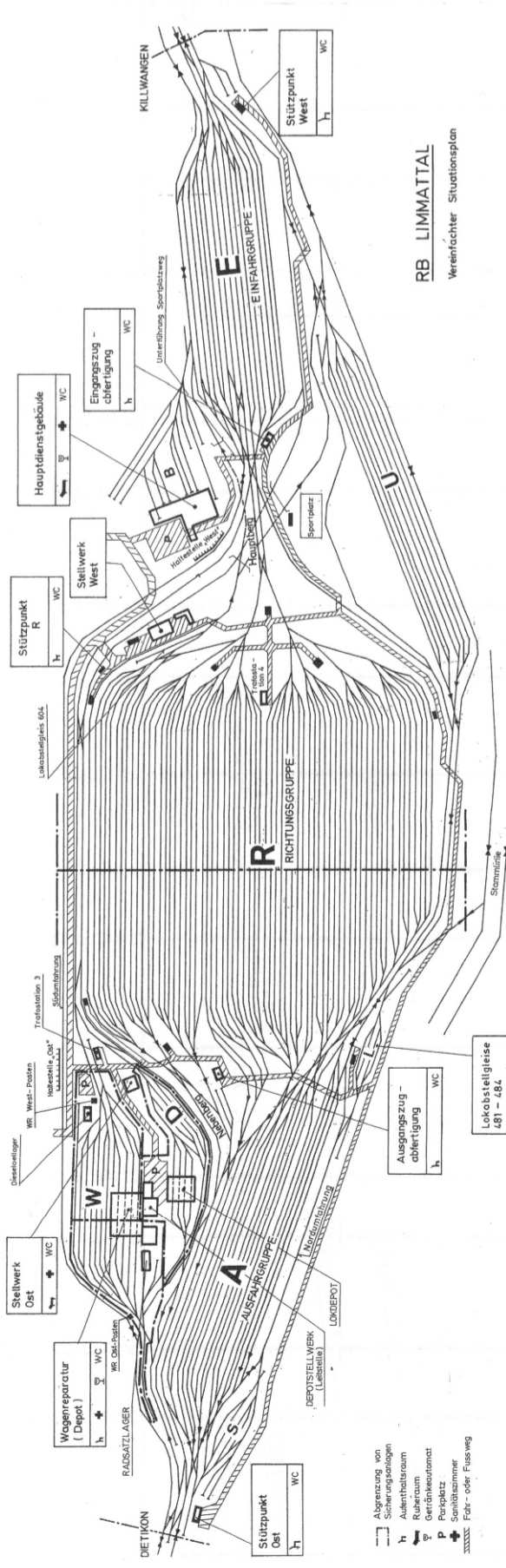

Abgrenzung von ...
 h Aufenthaltsraum
 r Ruheraum
 g Getränkautomat
 p Parkplatz
 s Sanitätszimmer
 f Fahr- oder Fußweg



SBB 60

I-FN-FPA-ROT

Ausgabe von 15.12.2013

Winterthur GB

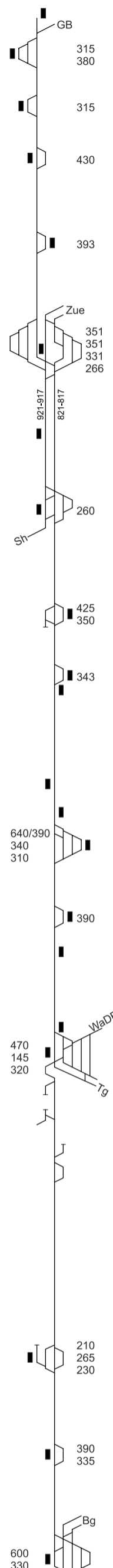
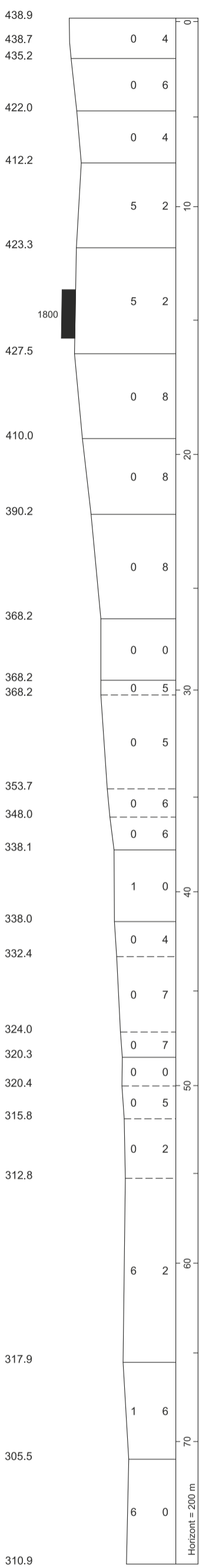

Station	Abstand	Kilometer
Winterthur West		
Winterthur	+	74.45
Winterthur West (Abzw)		
Winterthur Töss	+	1.72
		72.73
		2.96
W. Wülflingen	+	69.77
		2.90
Pfungen-N.	+	66.87
		4.74
Embrach-Rorbas	+	62.13
		3.94
v/n Zürich		
Bülach	+	58.19
		3.14
Glattfelden		
		2.85
Eglisau	+	52.20
v/n Schaffhausen		
		3.91
Zweidlen	+	48.29
		3.46
Weiach-K.	+	44.83
Kaiserstuhl AG		0.57
		44.26
		4.35
Rümikon AG		39.91
		1.65
Mellikon		38.26
		1.85
Rekingen AG	+	36.41
		3.36
Bad Zurzach	+	33.05
		1.99
Rietheim		31.06
		3.55
Koblenz Dorf		27.51
Koblenz	+	1.44
		26.07
Felsenau AG (Agl)		1.64
		24.43
Full (Agl)		1.86
		22.57
W AKW		3.39
Leibstadt (Agl)		19.18
		10.24
Laufenburg	+	8.94
		5.49
Sisseln	+	3.45
		3.45
v/n Brugg		
Stein-Säckingen	+	0.00

Höhe über Meer = 373.60
 RPN = 373.60
 Längsprofil
 Grösstes Gefälle
 Grösste Steigung
 Kilometrierung

Stationsanlage
 Abzweigungen
 Längste Ausweiche
 Blockstationen

v/n Basel
 Entfernung von Stat. zu Stat.
 Entfernung vom Ausgangspunkt

Mumpf

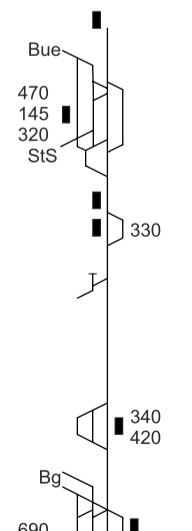
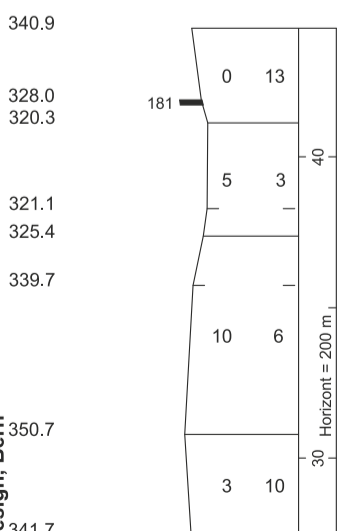

Station	Abstand	Kilometer
Waldshut	+	0.00
		1.74
Koblenz Grenze		1.74
Koblenz	+	1.57
		3.31
Koblenz Süd		1.00
		4.31
		1.86
Klingnau		6.17
Döttingen	+	0.91
		7.08
Beznau (Agl)		1.60
		8.68
		5.00
Siggenthal-W.	+	13.68
		3.33
Turgi	+	17.01
		4.90
Baden	+	2.27
		2.27
Wettingen	+	



SBB 61

I-FN-FPA-ROT

Ausgabe von 15.12.2013

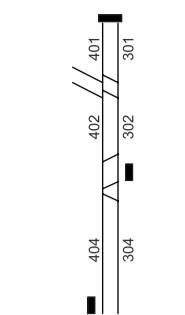
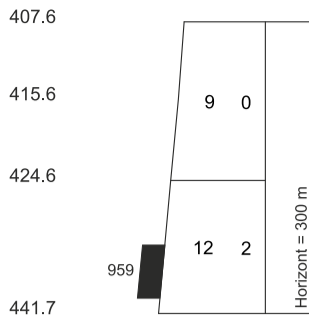

+	Zürich PB A 3-18	0.00
+	Q 51-54	1.40
+	Z Viadukt (Abzw)	1.40
+	Z Wipkingen	1.49
+		2.89
+		2.42
+	Z Oerlikon	5.31

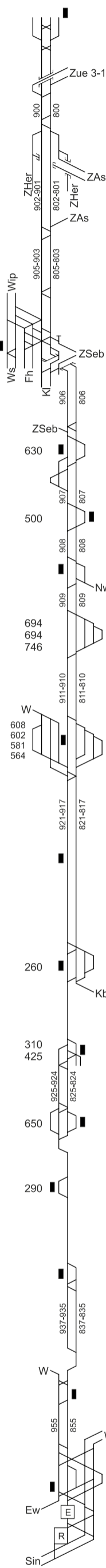
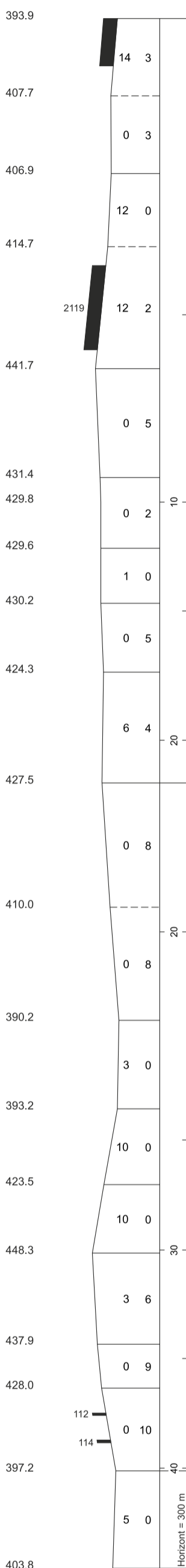

+	Zürich PB S21-24	0.00
+	Z Langstrasse	1.92
+	Z Hardbrücke	1.92
+	v/n Altstetten	1.35
+	Hard Käferberg (Abzw)	3.27
+		3.08
+	Z Oerlikon	6.35
+	v/n Seebach	2.49
+	Glattbrugg	8.84
+	Tankanlage Rümlang	3.34
+	Rümlang	12.18
+	Oberglatt	2.59
+	v/n Niederweningen	2.12
+	Niederglatt	16.89
+	v/n Winterthur	5.06
+	Bülach	21.95
+		3.14
+	Glattfelden	25.09
+		2.85
+	Eglisau	27.94
+	v/n Koblenz	1.35
+	Hüntwangen-Wil	29.29
+		3.44
+	Rafz	32.73
+		3.12
+	Lottstetten	35.85
+	Jestetten Süd (Verzw)	2.34
+	Jestetten	38.19
+		1.83
+		40.02
+		3.57
+	Fischerhölzli (Verzw)	43.59
+	v/n Winterthur	2.22
+	Neuhausen	45.81
+		2.23
+	Schaffhausen	48.04

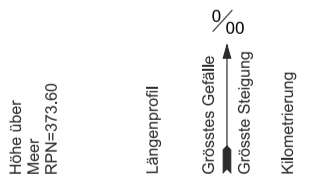

+	Singen (Htw.)	
+	Schaffhausen GB	
+	Schaffhausen	
+	Schaffhausen W203	
+	Herblingen	
+	Thayngen	
+	Bietingen	
+	Gottmadingen	
+	Singen (Htw.)	

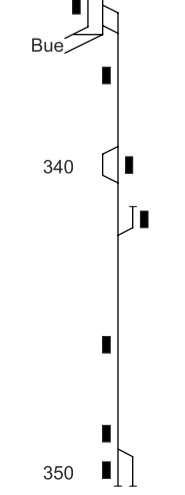
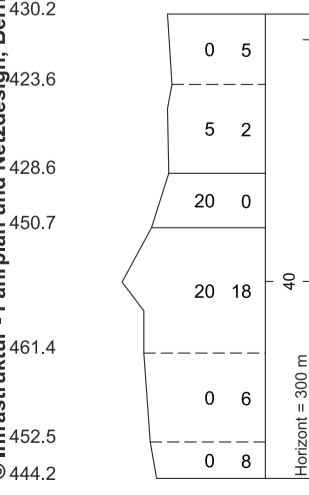

+	Oberglatt	0.00
+	Niederhasli	1.92
+		2.40
+	Dielsdorf	4.32
+	Steinmaur	1.33
+		5.65
+		2.86
+	Schöffliisdorf-Oberweningen	8.51
+		2.47
+	Niederweningen Dorf	10.98
+	Niederweningen	1.06
+		12.04

© Infrastruktur - Fahrplan und Netzdesign, Bern

DB

Entfernung von Stat. zu Stat.
Entfernung vom Ausgangspunkt

SBB 63 A

I-FN-FPA-ROT
Ausgabe von 15.12.2013

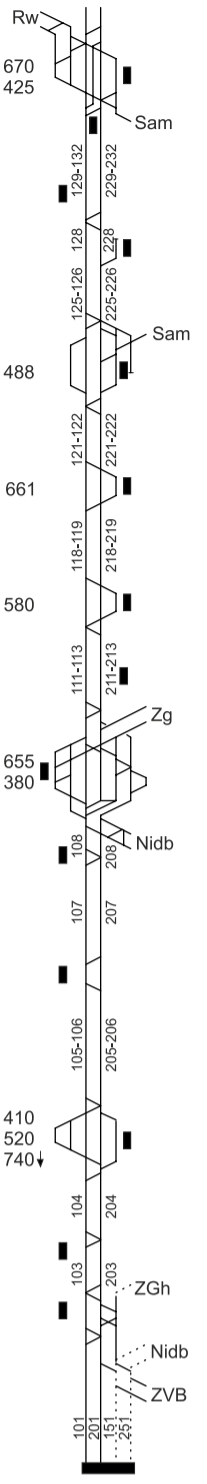
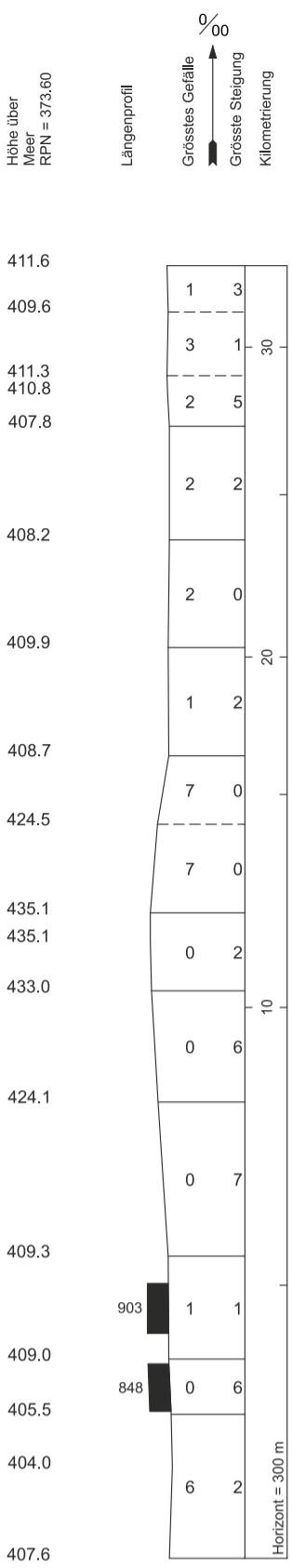

Blockstationen

Altendorf		
v/n Ziegelbrücke		
Pfäffikon SZ	33.08	
Freienbach SBB	1.73	31.35
Bäch	2.34	
Hafen Bäch (Spw)	0.64	29.01
Richterswil	1.27	28.37
		27.10
v/n Samstagern		
Wädenswil	3.48	
		23.62
	3.26	
Au ZH		20.36
	3.93	
Horgen		16.43
	2.54	
Oberrieden		13.89
v/n Zug		
Thalwil	2.14	
Thalwil Nord (Abzw)		11.75
Rüschlikon	1.45	
		10.30
	2.00	
Kilchberg		8.30
	2.83	
Z Wollishofen		5.47
	1.87	
Z Enge		3.60
Z Wiedikon	1.00	
		2.60
Z Aussersihl (Abzw)	0.91	
		1.69
v/n Zürich VB		
Zürich PB	1.69	
		0.00

Gl. 101/201

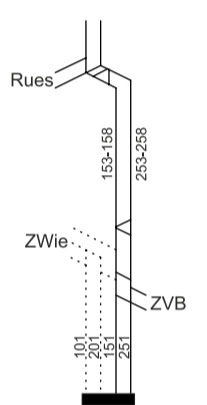

Thalwil Nord (Abzw)		11.67
Nidelbad (Abzw)	2.27	9.40
	6.26	
Z Kollerwiese		3.14
Z Aussersihl (Abzw)	1.45	1.69
v/n Zürich VB		
Zürich PB	1.69	0.00

Gl. 151/251

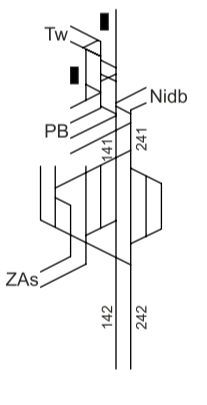

Z Giesshübel	1.03	
Z Wiedikon		4.18
Z Aussersihl (Abzw)	2.10	
Zürich VB		2.08
	2.08	
Z Altstetten		0.00

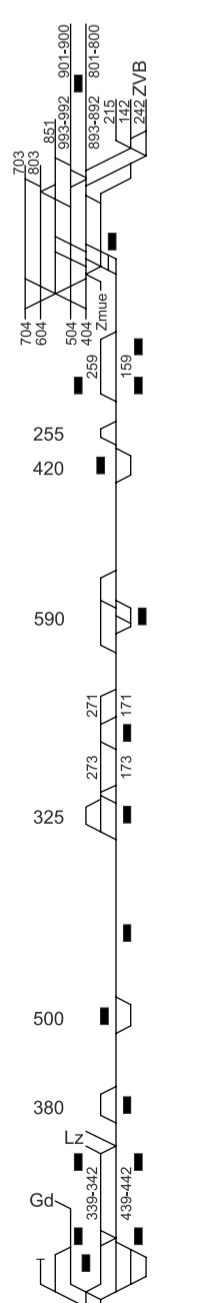
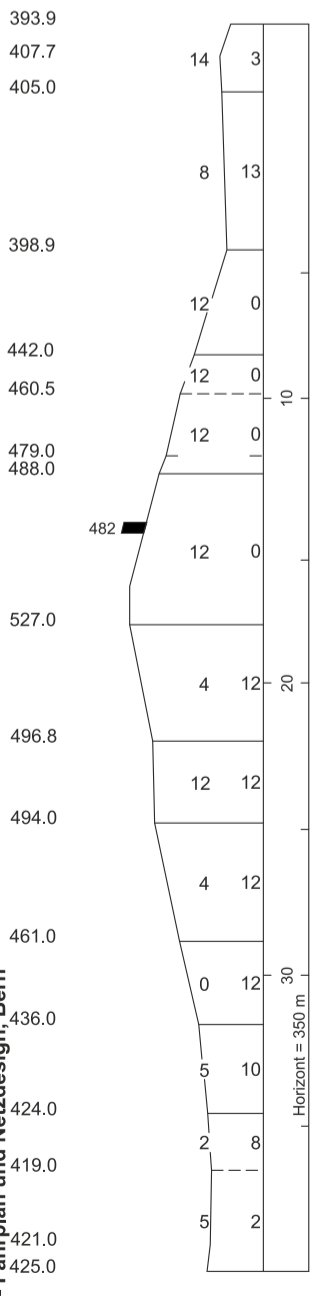

Zürich PB S21-24		0.00
Z Langstrasse	1.90	
Z Hardbrücke		1.90
	2.20	
Z Altstetten		4.10
	4.41	
Urdorf		8.51
Urdorf Weihermatt	1.33	9.84
Mören (Verzw)	2.17	
Birmensdorf Industrie	0.64	12.01
Birmensdorf ZH		12.65
	4.64	
Bonstetten Nord (Verzw)		17.29
Bonstetten-W.	0.70	17.99
Bonstetten Süd (Verzw)	0.96	18.95
	1.86	
Hedingen Nord (Verzw)		20.81
Hedingen	1.23	22.04
	2.73	
Affoltern am Albis		24.77
	4.07	
Mettmenstetten		28.84
	2.82	
Knonau		31.66
	3.00	
Steinhausen		34.66
v/n Luzern	1.63	
Kollermühle (Abzw)		36.29
Zug Chollemüli	0.23	36.52
	1.72	
v/n Goldau		
Zug Schutzengel		38.24
Zug	0.65	38.89

v/n Thalwil

Baar Lindenpark



SBB 64

I-FN-FPA-ROT

Ausgabe von 15.12.2013

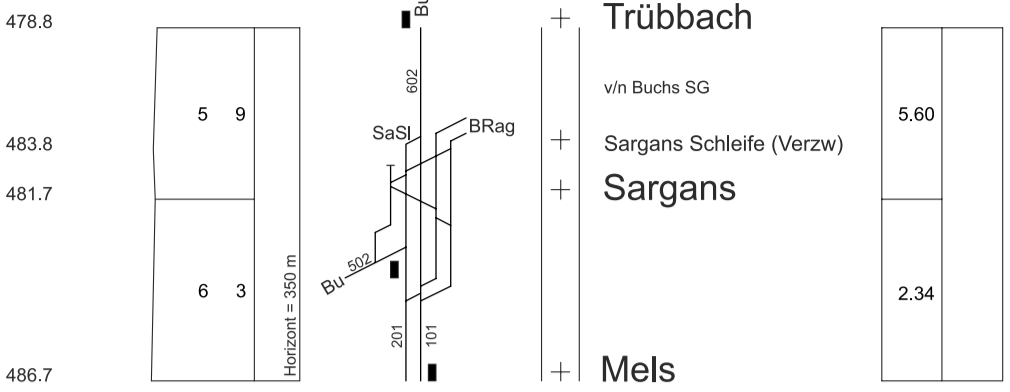

Trübbach

v/n Buchs SG
 Sargans Schleife (Verzw)
Sargans

Mels

	5.60
	2.34

Chur West

v/n Reichenau-Tamins

Chur GB
Chur

Chur GB
Chur

116.55
116.05

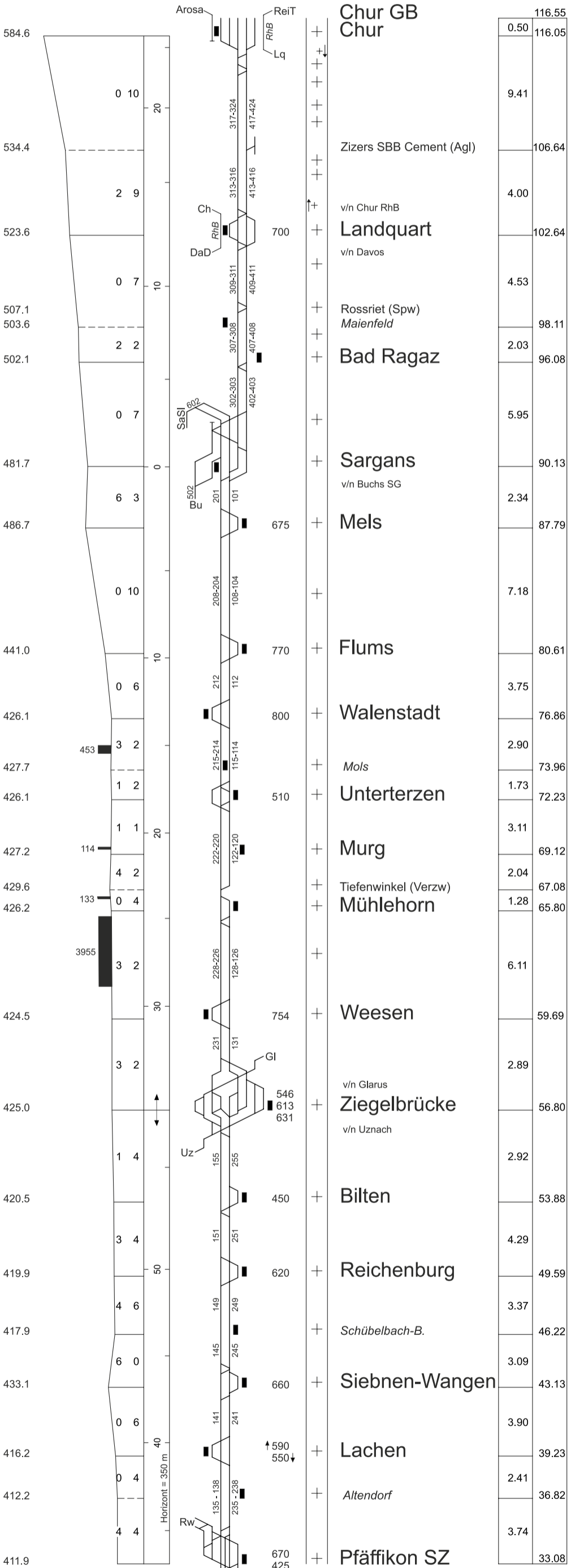

Zizers SBB Cement (Agl)

v/n Chur RhB
Landquart

v/n Davos

Rosriet (Spw)
Maienfeld

Bad Ragaz

Sargans

v/n Buchs SG

Mels

Flums

Walenstadt

Mols

Unterterzen

Murg

Tiefenwinkel (Verzw)

Mühlehorn

Weesen

v/n Glarus
Ziegelbrücke

v/n Uznach

Bilten

Reichenburg

Schübelbach-B.

Siebnen-Wangen

Lachen

Altendorf

Pfäffikon SZ

v/n Zürich

Freienbach SBB

Rapperswil

Hurden SOB
Pfäffikon SZ Nord (Abzw)

Pfäffikon SZ

v/n Samstagern

Freienbach SOB

	9.41
	106.64
	4.00
	102.64
	4.53
	98.11
	2.03
	96.08
	5.95
	90.13
	2.34
	87.79
	7.18
	80.61
	3.75
	76.86
	2.90
	73.96
	1.73
	72.23
	3.11
	69.12
	2.04
	67.08
	1.28
	65.80
	6.11
	59.69
	2.89
	56.80
	2.92
	53.88
	4.29
	49.59
	3.37
	46.22
	3.09
	43.13
	3.90
	39.23
	2.41
	36.82
	3.74
	33.08

Höhe über Meer RPN = 373.60

Längenprofil
 Grösstes Gefälle
 Grösste Steigung
 Kilometrierung

Stationsanlage
 Abzweigungen
 Längste Ausweicheise

Blockstationen

Entfernung von Stat. zu Stat.
 Entfernung vom Ausgangspunkt



I-FN-FPA-ROT

Ausgabe von 15.12.2013

Pfäffikon SZ

Pfäffikon Nord (Abzw)
Hurden SOB

Rapperswil

v/n Uznach

Blumenau

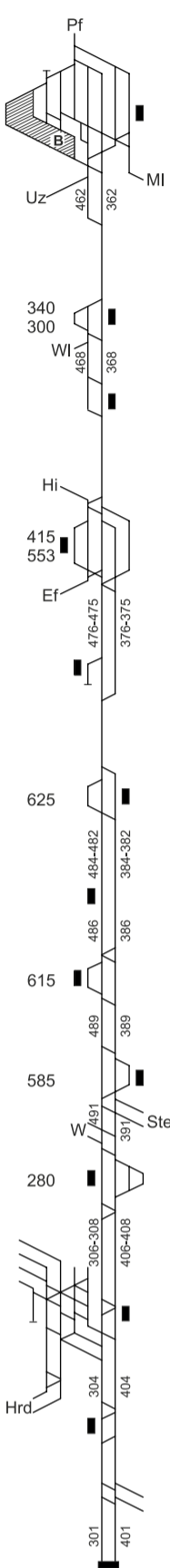
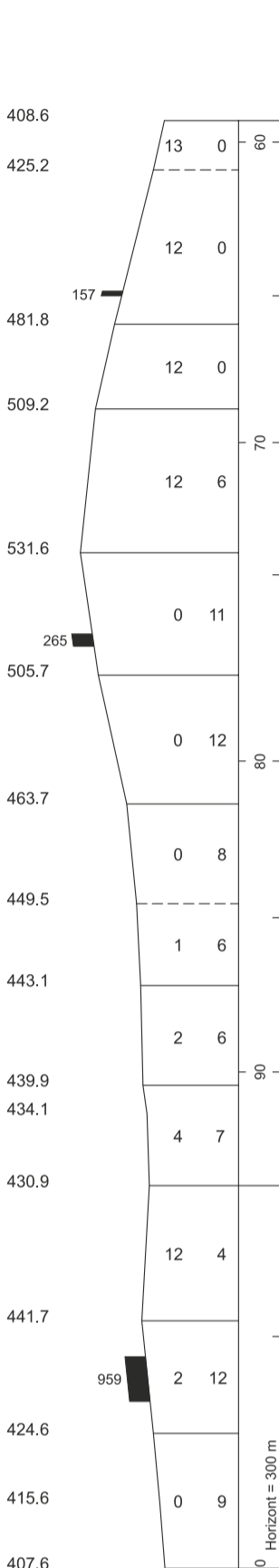

Rapperswil	42.84
Jona	1.60
Grünfels (Verzw)	41.24
	4.99
Rüti ZH	36.25
v/n Wald	2.72
Bubikon	33.53
v/n Hinwil	5.86
Wetzikon	27.67
v/n Effretikon	2.76
Aathal	24.91
	4.08
Uster	20.83
	3.21
Nänikon-Greifensee	17.62
	2.60
Schwerzenbach ZH	15.02
	3.28
Dübendorf	11.74
Chriesbach (Abzw)	0.81
	10.93
Wallisellen	1.98
	8.95
	3.64
Z Oerlikon	5.31
	2.42
Z Wipkingen	2.89
	1.49
Z Viadukt (Abzw)	1.40
	1.40
Zürich PB A 3-18 Q 51-54	0.00

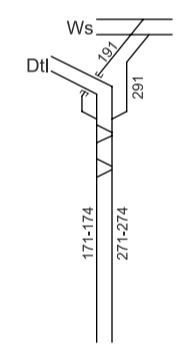
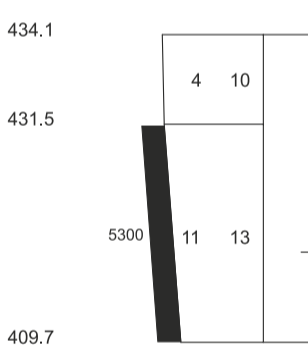

Chriesbach (Abzw)	
Stettbach	1.88
	5.35
Z Stadelhofen	

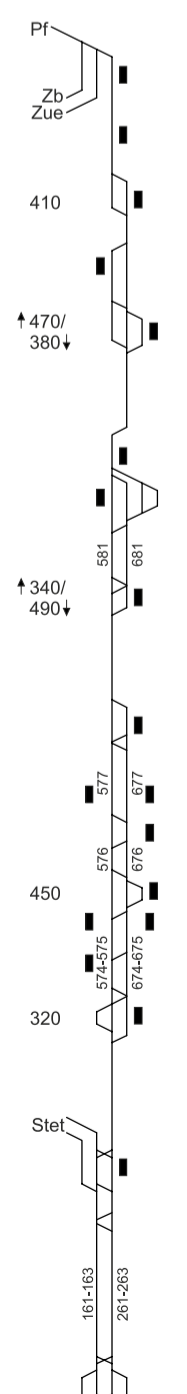
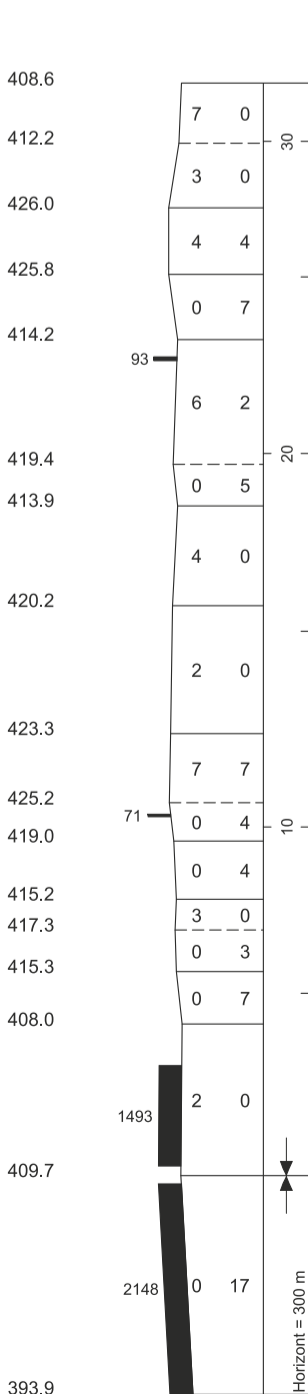

Rapperswil	32.07
Kempraten	2.14
	29.93
Feldbach	2.43
	27.50
Uerikon	2.43
	25.07
Stäfa	2.49
	22.58
	2.83
Männedorf	19.75
Uetikon	1.23
	18.52
	2.96
Meilen	15.56
	2.85
Herrliberg-F.	12.71
	2.03
Winkel am Zürichsee	10.68
Erlenbach ZH	1.11
	9.57
Küsnacht ZH	1.74
Küsnacht Goldbach	0.93
	6.90
Zollikon	1.27
	5.63
Z Tiefenbrunnen	1.59
	4.04
	2.24
v/n Stettbach	
Z Stadelhofen	1.80
	1.80
Zürich PB S21-24	0.00

© Infrastruktur - Fahrplan und Netzdesign, Bern

Höhe über Meer = 373.60
RPN = 373.60

Längenprofil
Grösstes Gefälle
Grösste Steigung
Kilometrierung

Stationsanlage
Abzweigungen
Längste Ausweichgleise

Blockstationen
v/n Hardbrücke

Entfernung von Stat. zu Stat.
Entfernung vom Ausgangspunkt



SBB

66

I-FN-FPA-ROT

Ausgabe von 15.12.2013

Bubikon

v/n Rapperswil

Wetzikon

v/n Uster

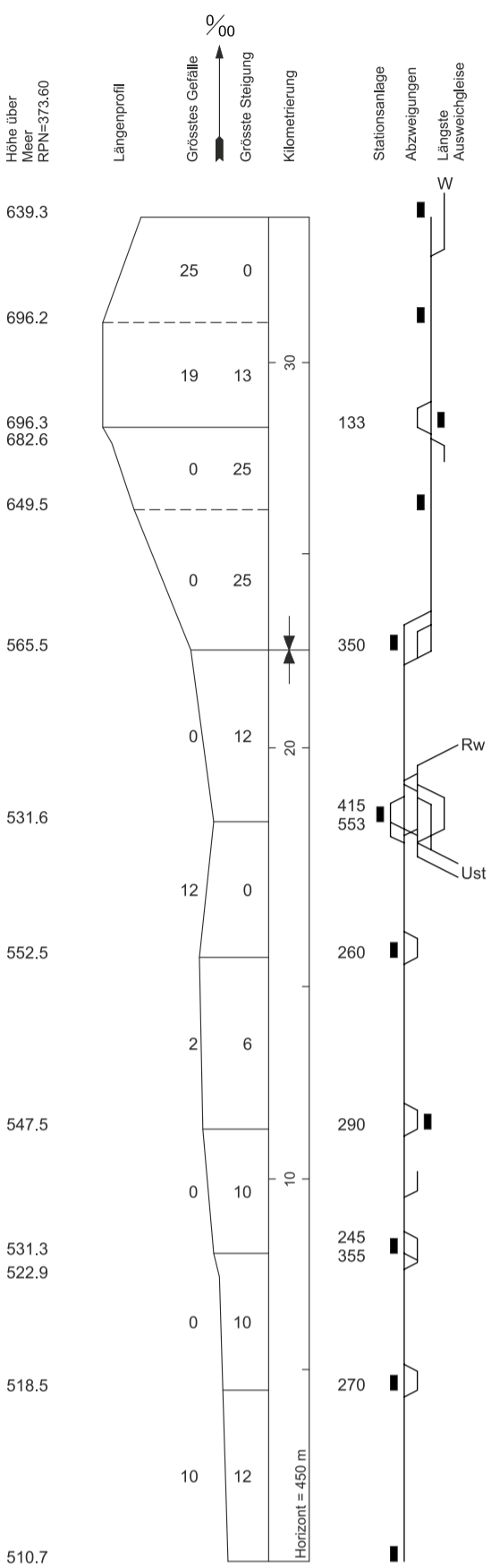

Blockstationen	Entfernung von Stat. zu Stat.	Entfernung vom Ausgangspunkt
Aathal		
Bauma	2.79	33.85
Neuthal	2.79	31.06
Bäretswil	0.64	28.27
Bäretswil Tobel (Agl)	1.47	27.83
Ettenhausen-Emmetschloo	3.61	26.16
Hinwil	4.44	22.55
Wetzikon	2.34	18.11
Kempton	4.42	15.77
Pfäffikon ZH	1.65	11.35
Witzberg (Agl)	1.67	9.70
Fehraltorf	0.64	8.03
Fehraltorf Industrie	2.91	7.39
Illnau	4.48	4.48
Effretikon	0.00	0.00

© Infrastruktur - Fahrplan und Netzdesign, Bern

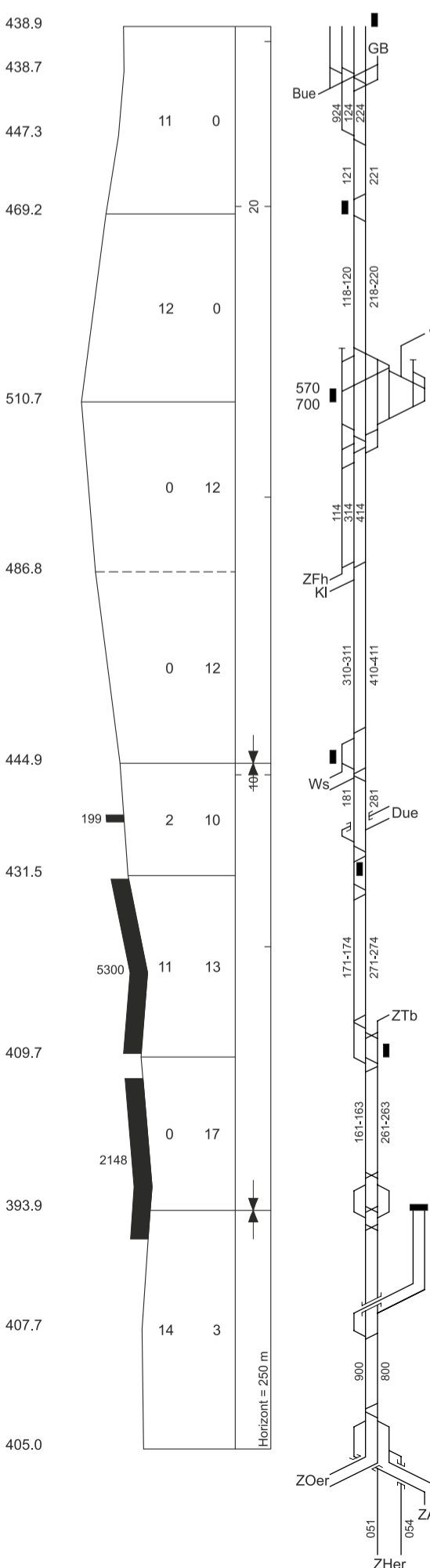

Blockstationen	Entfernung von Stat. zu Stat.	Entfernung vom Ausgangspunkt
Winterthur		25.43
Winterthur West (Abzw)	3.29	
Tössmühle (Verzw)	2.36	22.14
Kemptthal	3.67	19.78
Effretikon	2.00	16.11
Hürlistein (Abzw)	3.77	14.11
Dietlikon	3.24	10.34
v/n Wallisellen	3.24	
v/n Dübendorf	5.35	7.10
Stettbach	1.75	
v/n Tiefenbrunnen	1.75	
Z Stadelhofen	0.00	1.75
Zürich PB S21-24		0.00
Z Langstrasse	1.92	
Z Hardbrücke		
Z Herdern		



SBB 70 A

I-FN-FPA-ROT

Ausgabe von 15.12.2013

Winterthur

Gl. 46

Winterthur West (Abzw)

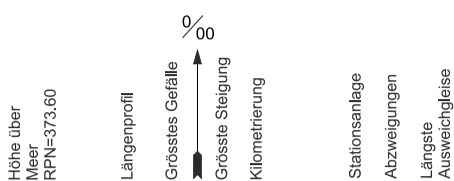

Blockstationen

Winterthur GB

Entfernung von Stat. zu Stat.
Entfernung vom Ausgangspunkt

Winterthur West (Abzw)

Winterthur Grüze

v/n St. Gallen
Bauma

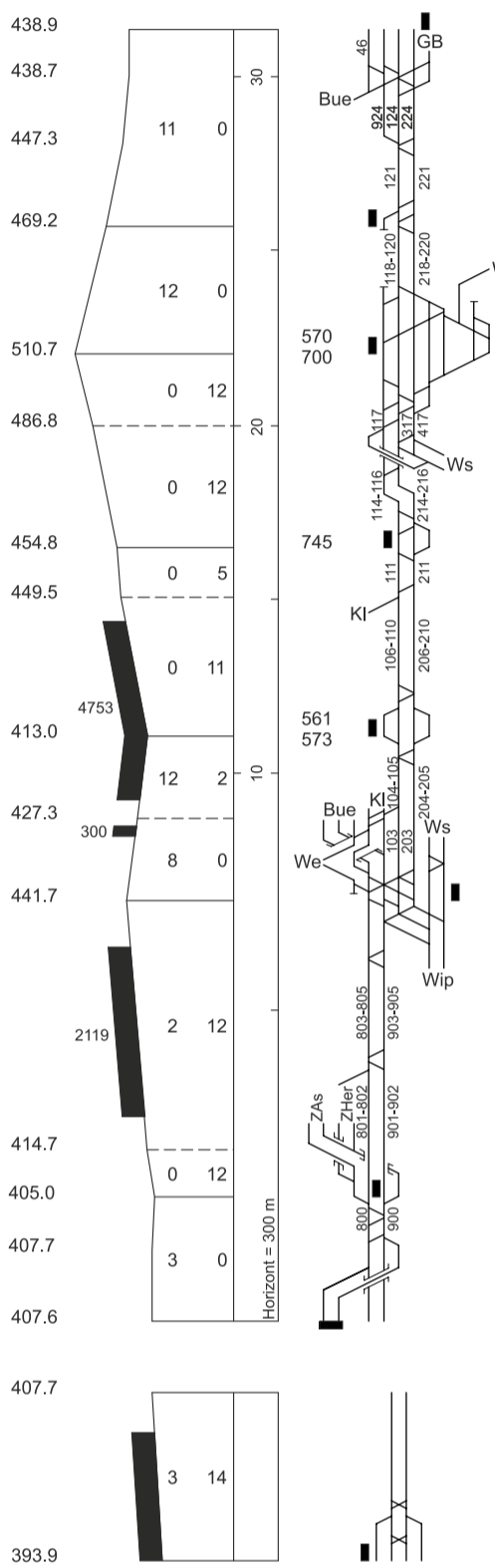

+	Winterthur Gl. 45 / 44 / 43 Winterthur West (Abzw)	31.33
+	Tössmühle (Verzw)	28.04
+	Kemptthal	25.68
+	Effretikon	22.01
+	Hürlistein (Abzw)	20.01
+	Bassersdorf	16.54
+	Dorfneft (Abzw)	15.05
+	Z Flughafen	11.11
+	Opfikon Opfikon Süd (Abzw)	8.80 8.13
+	Z Oerlikon	6.35
+	Hard Käferberg (Abzw)	3.27
+	Z Hardbrücke	1.92
+	Z Langstrasse	0.92
+	Zürich PB A3-18	0.00
+	Z Langstrasse	0.92
+	Zürich PB S21-24	0.00

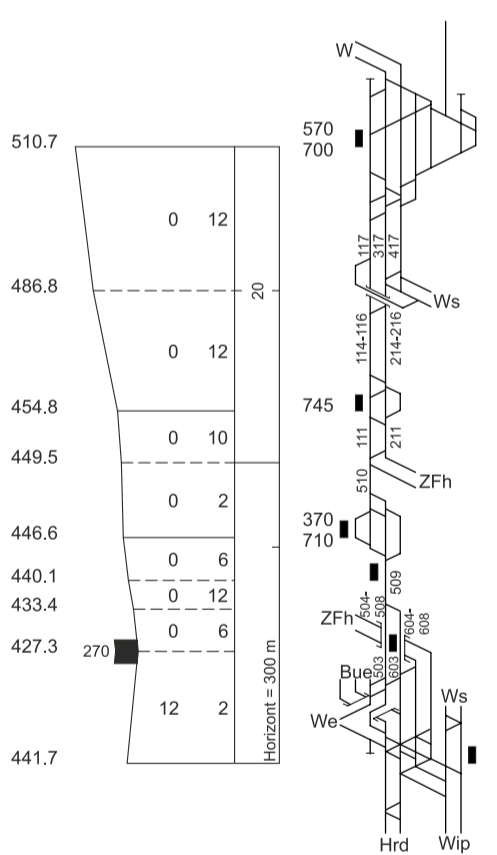

+	Illnau	
+	v/n Wetzikon	
+	Effretikon	22.01
+	Hürlistein (Abzw)	20.01
+	Bassersdorf	16.54
+	Dorfneft (Abzw)	7.38
+	Kloten	5.26
+	Kloten Balsberg	4.05
+	Riet (Verzw)	3.43
+	Opfikon	2.45
+	Opfikon Süd (Abzw)	1.78
+	v/n Seebach	
+	Z Oerlikon	0.00

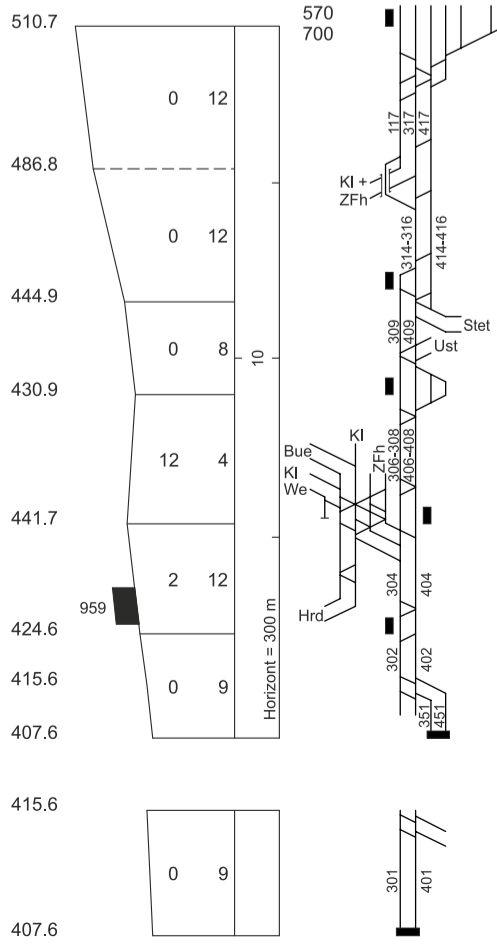

+	Effretikon	17.40
+	Hürlistein (Abzw)	15.40
+	Dietlikon v/n Stettbach	11.63
+	v/n Uster	
+	Wallisellen	8.95
+	Z Oerlikon	5.31
+	Z Wipkingen	2.89
+	Z Viadukt (Abzw) Gl. 351 / 451	1.40
+	Zürich PB A3-18 Q51-54	0.00
+	Z Viadukt (Abzw)	1.40
+	Gl. 301/401	1.40
+	Zürich PB A3-18 Q51-54	0.00

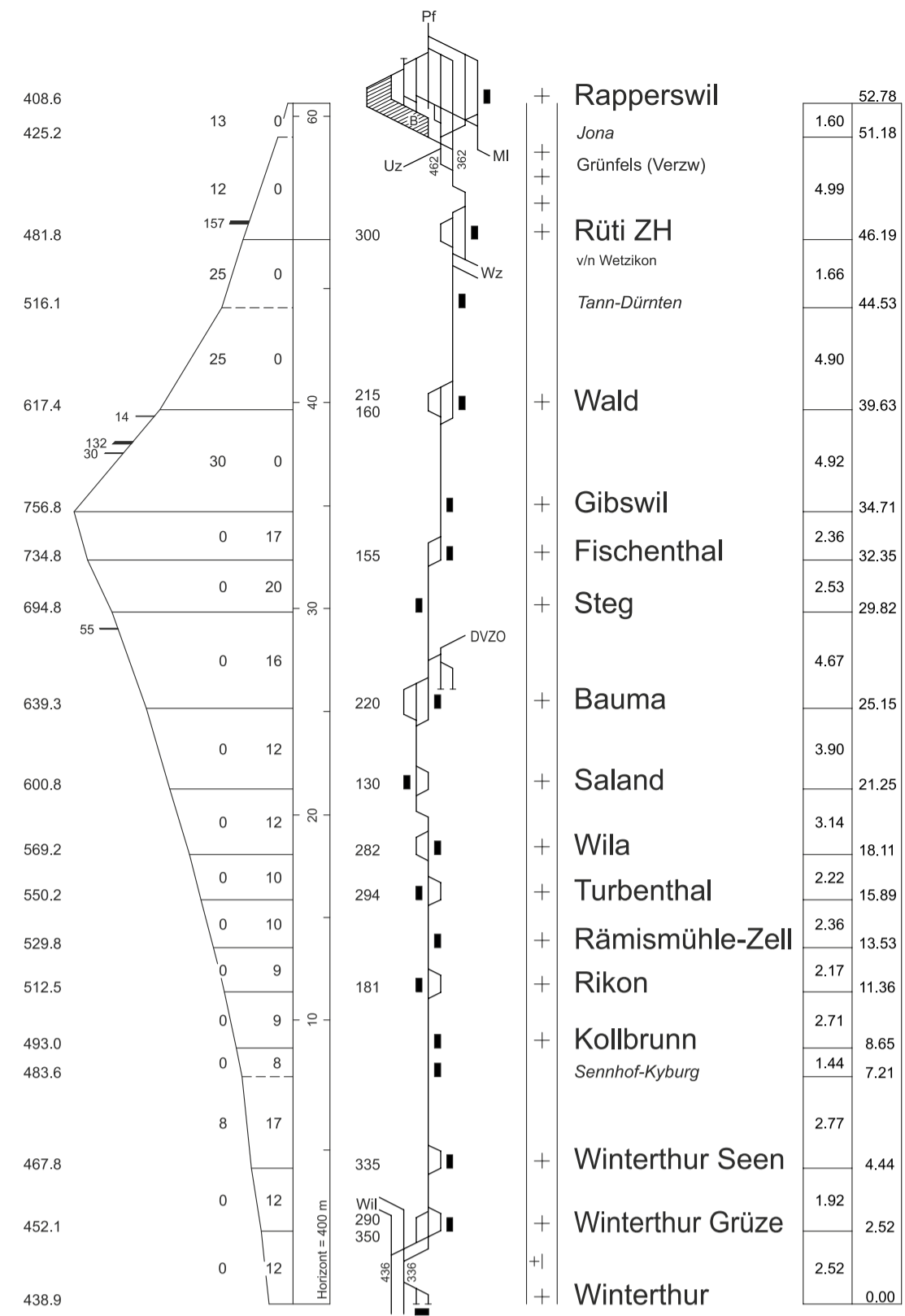

SBB 71 St. Gallen GB

I-FN-FPA-ROT
Ausgabe von 15.12.2013

St. Gallen West
SG St. Fiden

v/n Rorschach
 Romanshorn

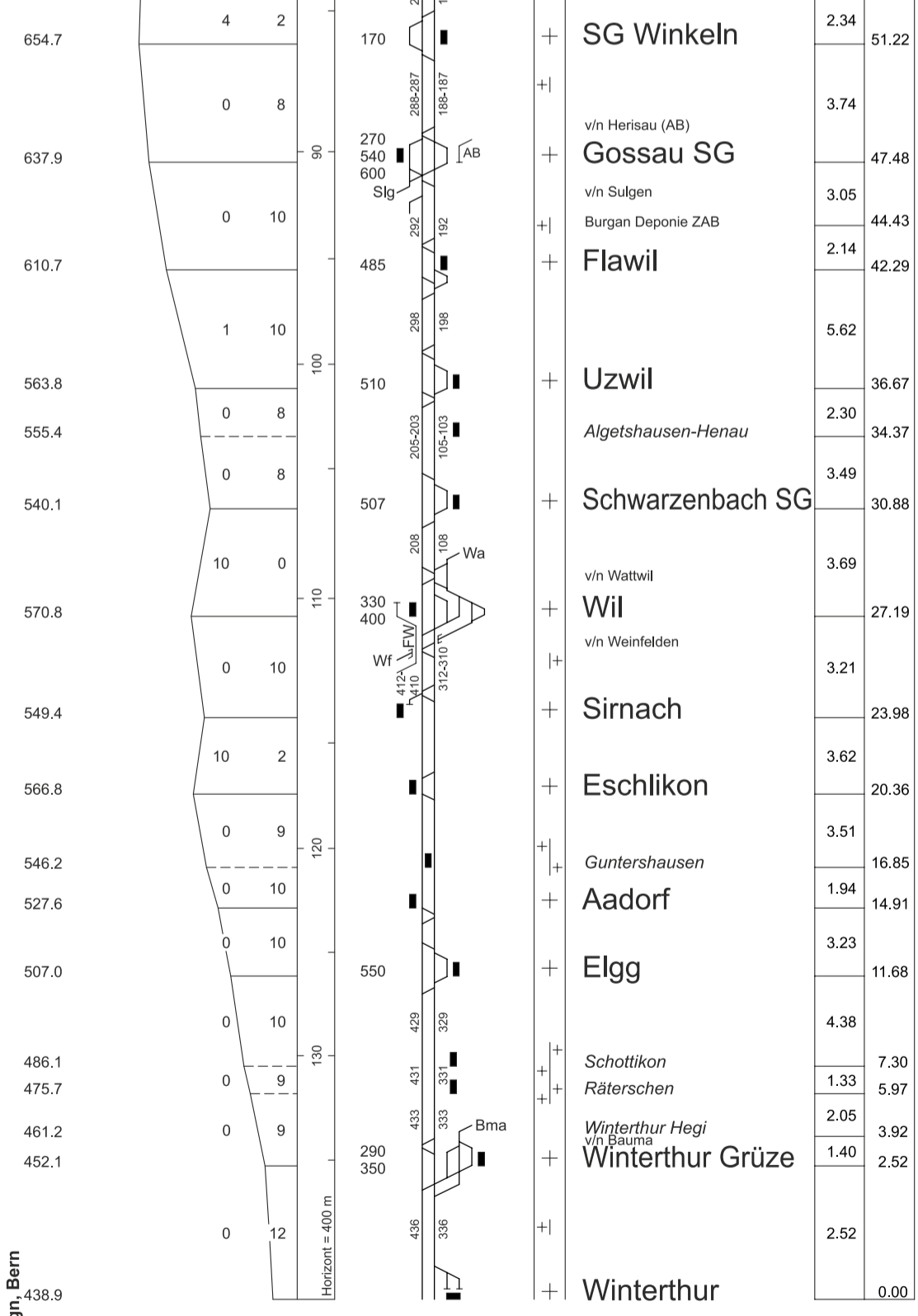

v/n Zürich
 Winterthur West

Winterthur
 Winterthur GB

Entfernung von Stat. zu Stat.
 Entfernung vom Ausgangspunkt

© **Infrastruktur - Fahrplan und Netzdesign, Bern**
 Höhe über Meer
 RPN=373.60

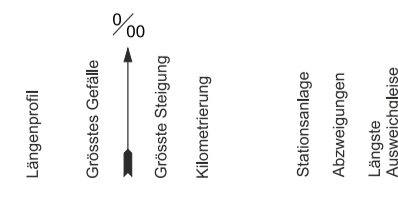



SBB

72

I-FN-FPA-ROT

Ausgabe von 15.12.2013

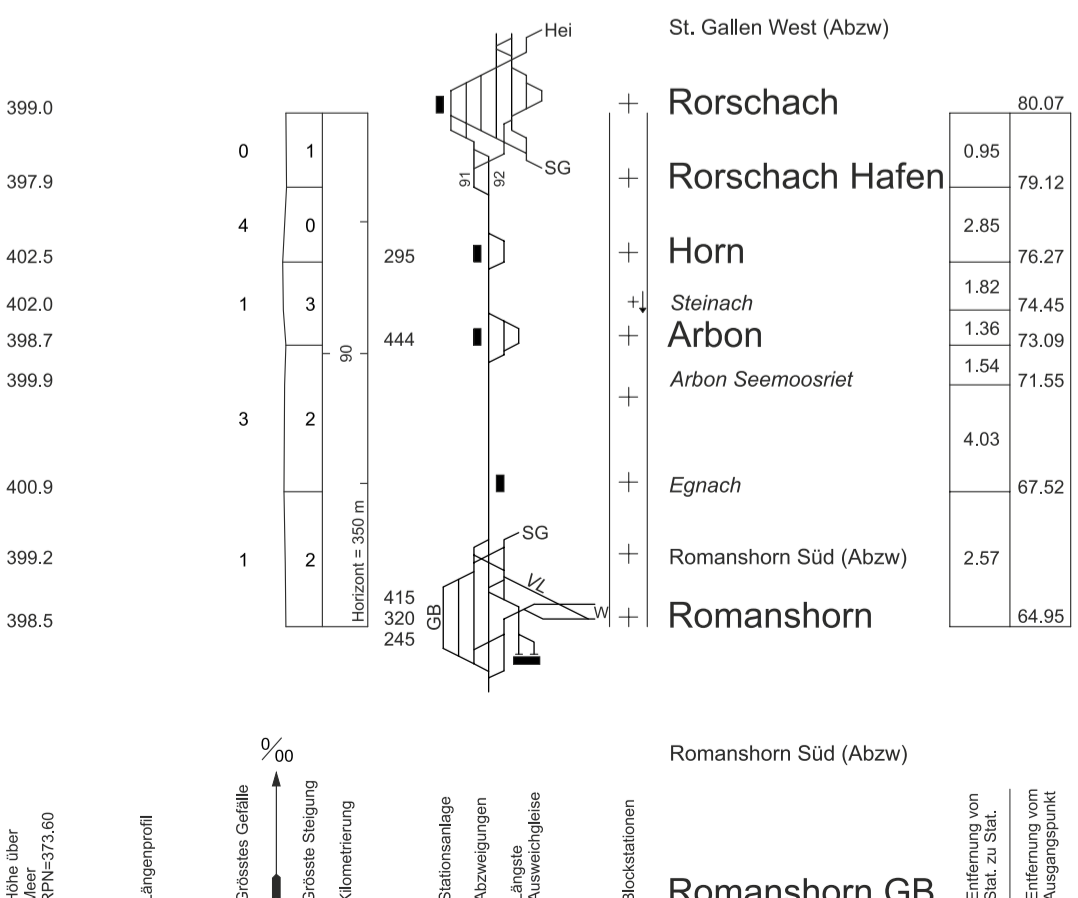
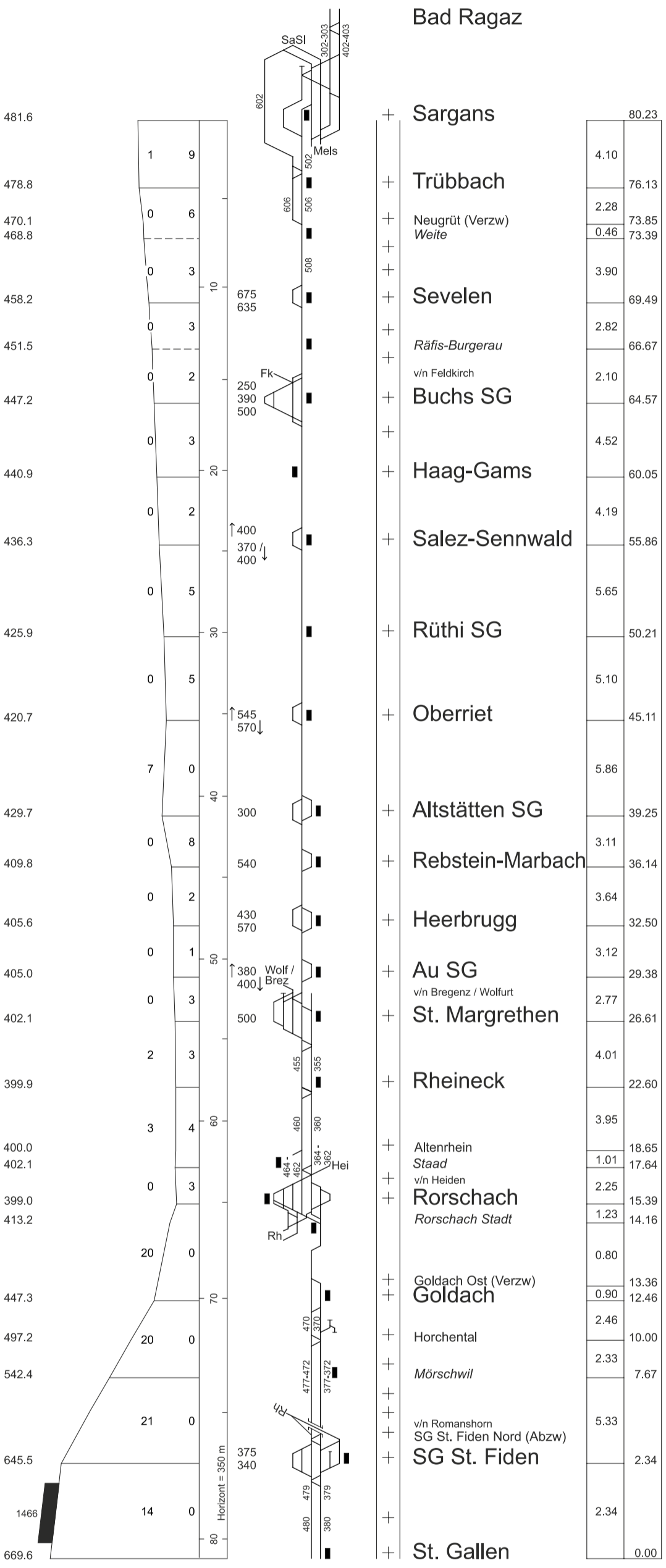
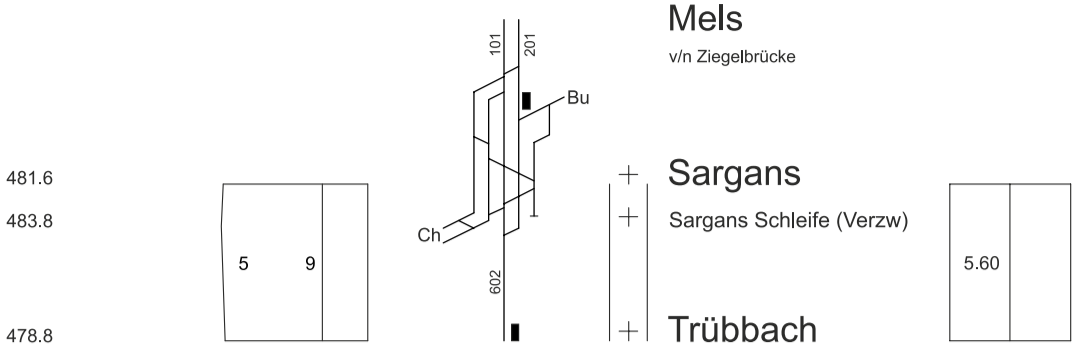

© Infrastruktur - Fahrplan und Netzdesign, Bern

Höhe über Meer
RPN=373.60

Längenprofil

Grösstes Gefälle
Grösste Steigung
Kilometrierung

Stationsanlage
Abzweigungen
Längste Auswechgleise

Blockstationen

Entfernung von Stat. zu Stat.
Entfernung vom Ausgangspunkt

Romanshorn



SBB 73

I-FN-FPA-ROT

Ausgabe von 15.12.2013

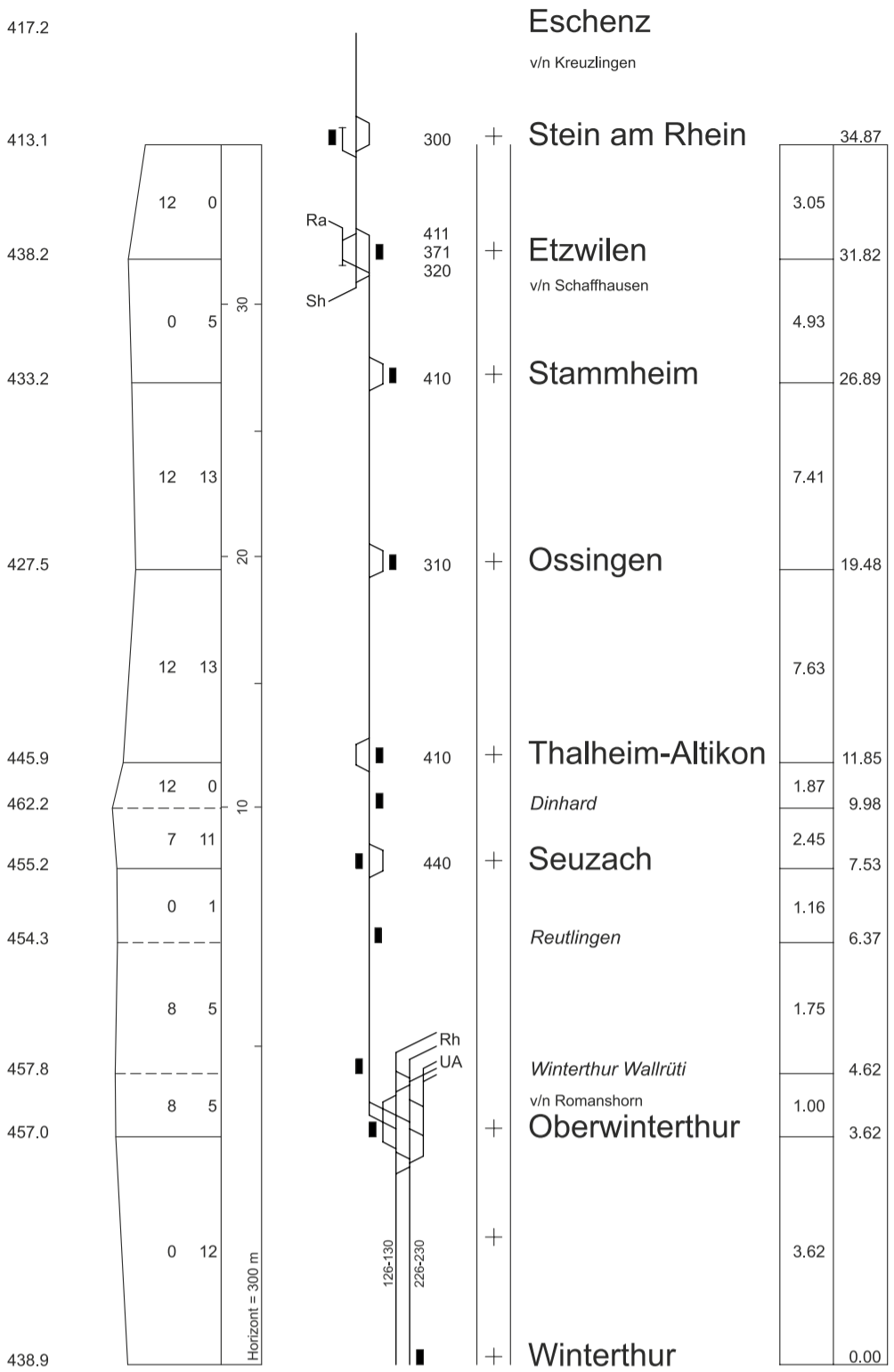

Winterthur GB

Schaffhausen GB

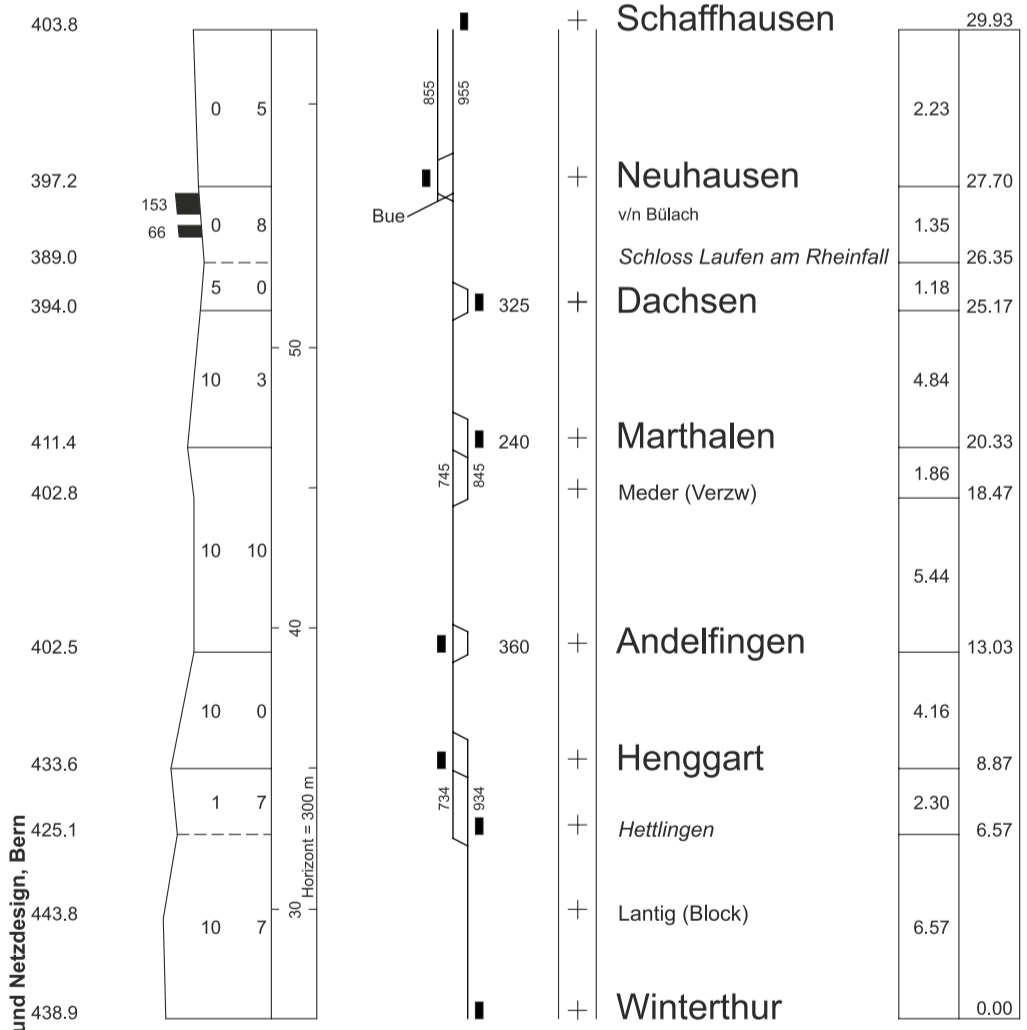

Winterthur GB

© Infrastruktur - Fahrplan und Netzdesign, Bern
 Höhe über Meer
 RPN=373,60

Längenprofil
 Grösstes Gefälle
 Grösste Steigung
 Kilometrierung

Stationsanlage
 Abzweigungen
 Längste Ausweichleise

Blockstationen

Entfernung von Stat. zu Stat.
 Entfernung vom Ausgangspunkt



SBB 74

I-FN-FPA-ROT

Ausgabe von 15.12.2013

St. Gallen GB

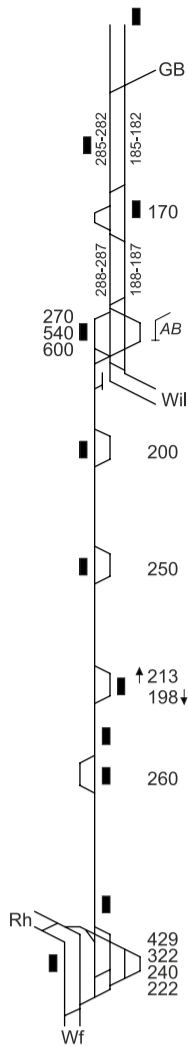
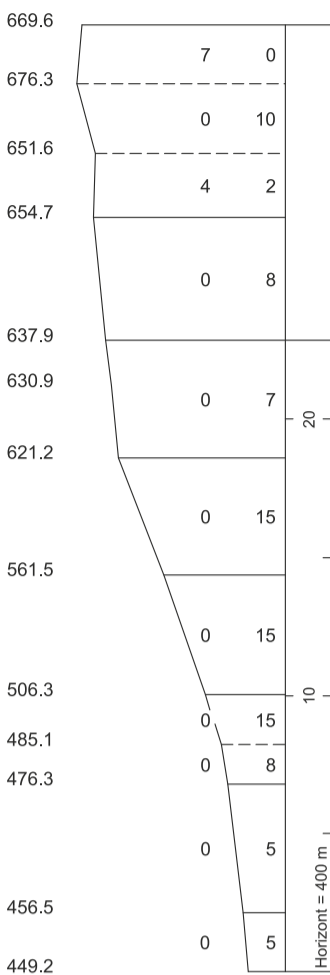

St. Gallen West (Abzw)

Station	Distance (km)	Elevation (m)
St. Gallen	32.62	
St. Gallen West (Abzw)	1.05	31.57
St. Gallen Bruggen	2.54	29.03
SG Winkeln	2.34	26.69
Gossau SG	3.74	22.95
Gossau Sommerau (Agl)	4.36	
Arnegg	4.21	18.59
Hauptwil	4.33	14.38
Bischofszell Stadt	10.05	
Sitterdorf	1.85	8.20
Bischofszell Nord	1.42	6.78
Kradolf	4.66	2.12
Sulgen	2.12	0.00

Romanshorn Süd (Abzw)

v/n Rorschach
Romanshorn

Uttwil

Romanshorn Süd (Abzw)

Romanshorn VL

Romanshorn West (Abzw)

Station	Distance (km)	Elevation (m)
Romanshorn	56.12	
Romanshorn West (Abzw)	6.57	

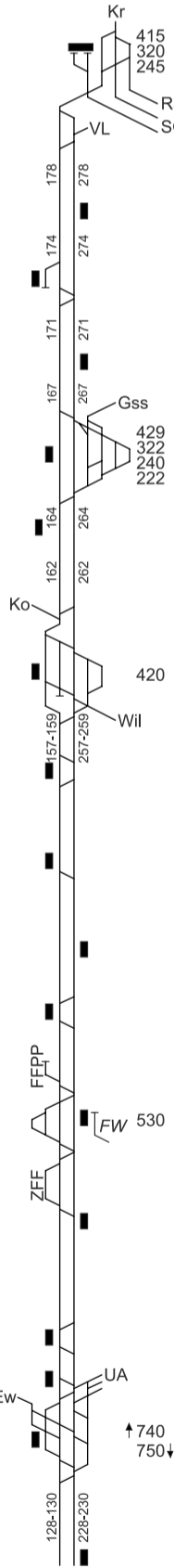
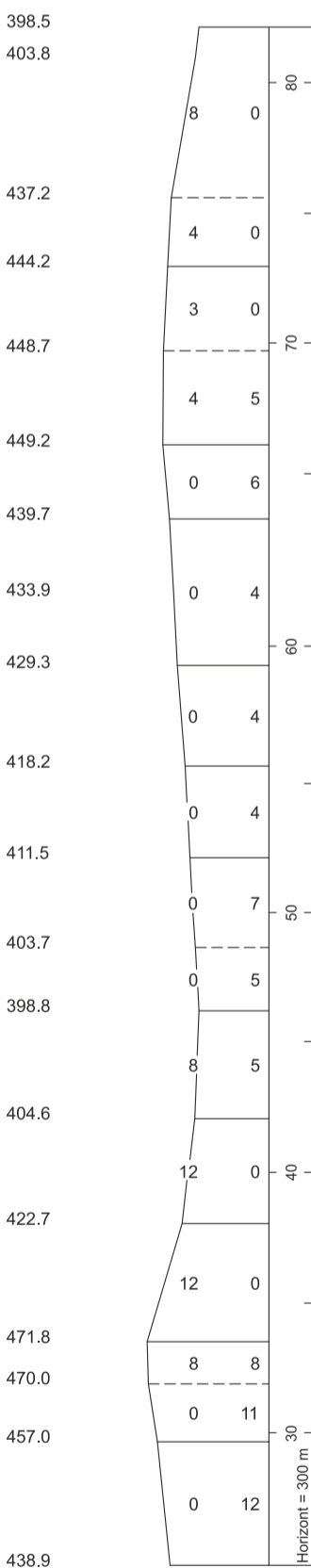

Romanshorn

Station	Distance (km)	Elevation (m)
Romanshorn	56.12	
Romanshorn West (Abzw)	6.57	
Amriswil	49.55	
Oberaach	2.67	46.88
Erlen	3.21	43.67
Sulgen	3.60	40.07
Bürglen	2.83	37.24
Weinfelden KVA TG (Agl)	1.99	35.25
Weinfelden	1.80	33.45
Märstetten	3.80	29.65
Müllheim-Wigoltingen	3.57	26.08
Hüttlingen-Mettendorf	3.45	22.63
Felben-Wellhausen	2.47	20.16
Frauenfeld	4.14	16.02
Islikon	4.00	12.02
Rickenbach-Attikon	4.52	7.50
Wiesendangen	1.61	5.89
Oberwinterthur	2.27	3.62
Winterthur	3.62	0.00

v/n Zürich

Winterthur West (Abzw)

Unterhaltsanlage

Oberwinterthur

Winterthur

Winterthur GB



SBB

75

I-FN-FPA-ROT

Ausgabe von 15.12.2013

Schwarzenbach SG

v/n St. Gallen

Wil

v/n Winterthur

Sirnach

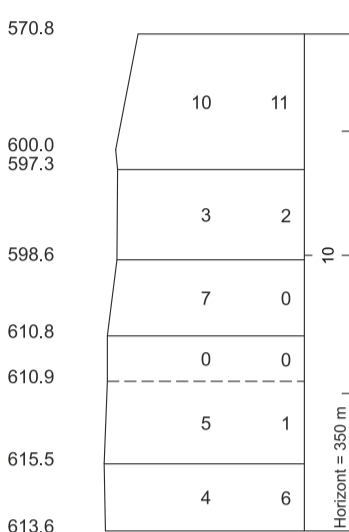

Wil

Bazenheid ZAB (Agl)
Bazenheid

Lütisburg

Bütschwil

Dietfurt

Lichtensteig

Wattwil

v/n Nesslau

Ebnat-Kappel

Brunnadern-Neckertal

v/n St. Gallen

Lichtensteig

Wattwil

Kaltbrunn

v/n Ziegelbrücke

Uznach

Schmerikon

Weesen

v/n Sargans

Ziegelbrücke

v/n Zürich

Bilten

Linthal

Linthal Braunwaldbahn

Rüti GL

Diesbach-Betschwanden

Luchsingen-Hätzingen

Leuggelbach

Nidfurn-Haslen

Schwanden

Mitlödi

Ennenda

Glarus

Netstal

Näfels-Mollis

Nieder- und Oberurnen

Ziegelbrücke

Schänis

Benken

v/n Wattwil

Uznach

Schmerikon

Bollingen

Blumenau

Rapperswil

Hurden
Pfäffikon SZ Nord (Verzw)

Pfäffikon SZ

Höhe über Meer
RPN=373.60

Langenprofil

Grösstes Gefälle

Grösste Steigung

Kilometrierung

Stationsanlage

Abzweigungen

Längste Auswechgleise

Blockstationen

Entfernung von Stat. zu Stat.

Entfernung vom Ausgangspunkt

© Infrastruktur - Fahrplan und Netzdesign, Bern

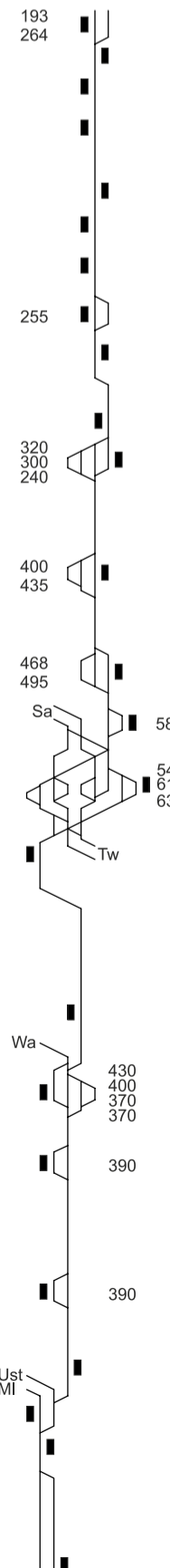
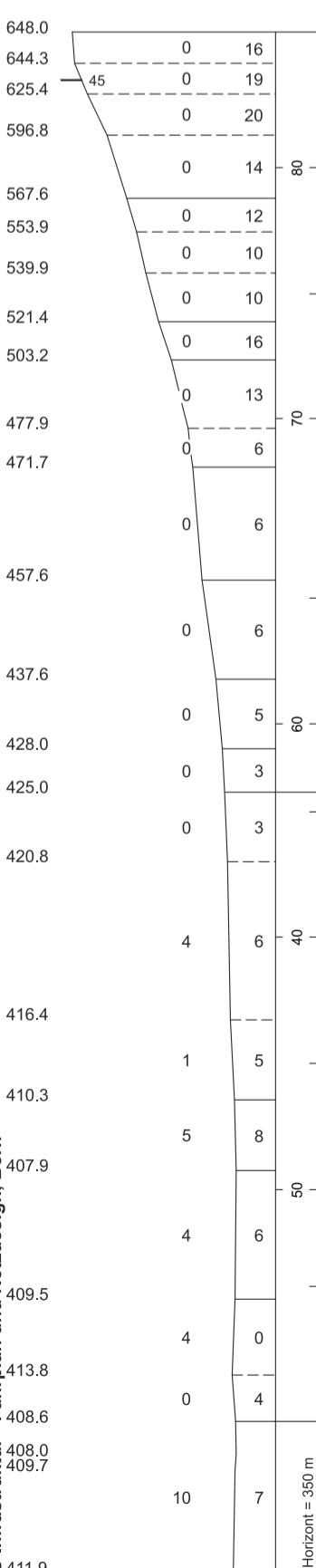

	52.28
0.40	51.88
1.20	50.68
1.60	49.08
2.57	46.51
1.31	45.20
1.60	43.60
1.96	41.64
1.55	40.09
2.78	
	37.31
0.88	36.43
2.97	
	33.46
3.98	
	29.48
2.74	
1.76	26.74
2.77	24.98
	22.21
6.29	
	15.92
3.12	
	12.80
2.83	
	9.97
5.09	
	4.88
3.01	
1.87	
1.87	0.00
4.05	



SBB 76

I-FN-FPA-ROT

Ausgabe von 15.12.2013

Weinfelden KVA TG

v/n Romanshorn

Weinfelden

v/n Winterthur

Märstetten

Kurzrickenbach Seepark

v/n Romanshorn

Kreuzlingen Hafen

Kreuzlingen

Kreuzlingen Hafen
Kreuzlingen Hafen Grenze

Konstanz

Singen (Htw)

Radolfzell

DB

Konstanz

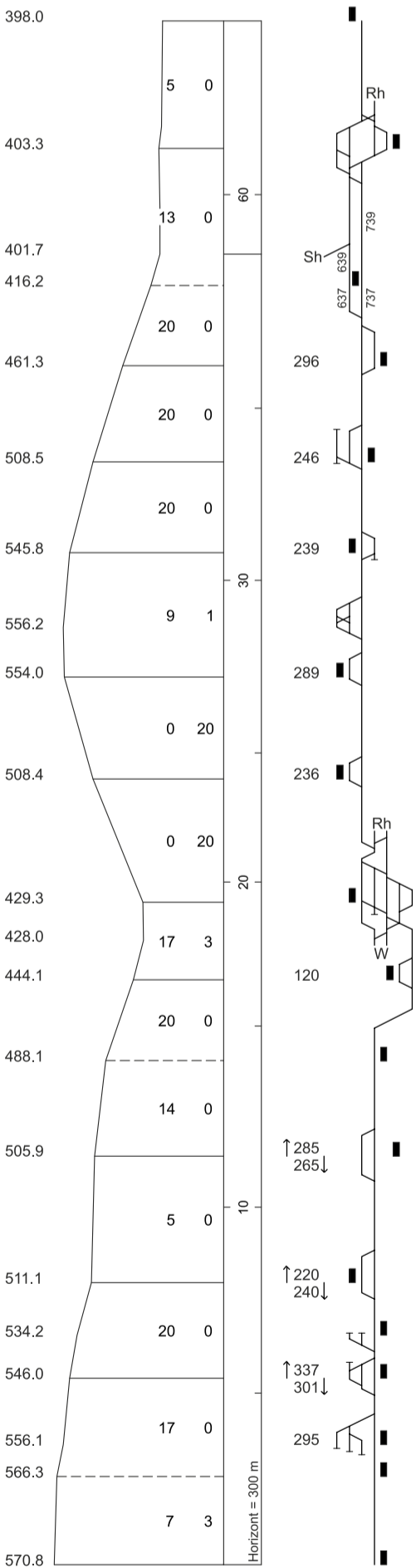

+	Konstanz	42.31
+	Kreuzlingen Grenze	0.50
+	Kreuzlingen	41.81
		0.67
		41.14
		1.54
+	Tägermoos (Abzw)	39.60
+	<i>Tägerwilen Dorf</i>	0.97
		38.63
		2.38
+	Kreuzlingen Bernrain	36.25
		2.79
+	Lengwil	33.46
		2.68
+	Siegershausen	30.78
		2.13
	Altishausen (Agl)	28.65
+	Berg	27.23
		1.42
		2.92
+	Kehlhof	24.31
		5.14
+	Weinfelden	19.17
	Weinfelden Süd (Agl)	1.60
		17.57
+	Bussnang	16.35
		1.22
		2.31
	<i>Oppikon</i>	14.04
		2.79
+	Märwil	11.25
		3.03
+	Tobel-Affeltrangen	8.22
		1.51
	<i>Tägerschen</i>	6.71
+	Bettwiesen	5.45
		1.26
+	Bronschhofen AMP	3.51
		1.94
	<i>Bronschhofen</i>	2.58
		0.93
+	Wil	0.00
		2.58

v/n Wattwil

Bazenheid

© Infrastruktur - Fahrplan und Netzdesign, Bern

Höhe über Meer
RPN=373.60

Längenprofil

Grösstes Gefälle
Grösste Steigung

Stationsanlage
Abzweigungen
Längste Ausweingleise

Blockstationen

Sirnach

v/n Winterthur

Wil

v/n St. Gallen

Schwarzenbach SG

Entfernung von Stat. zu Stat.
Entfernung vom Ausgangspunkt

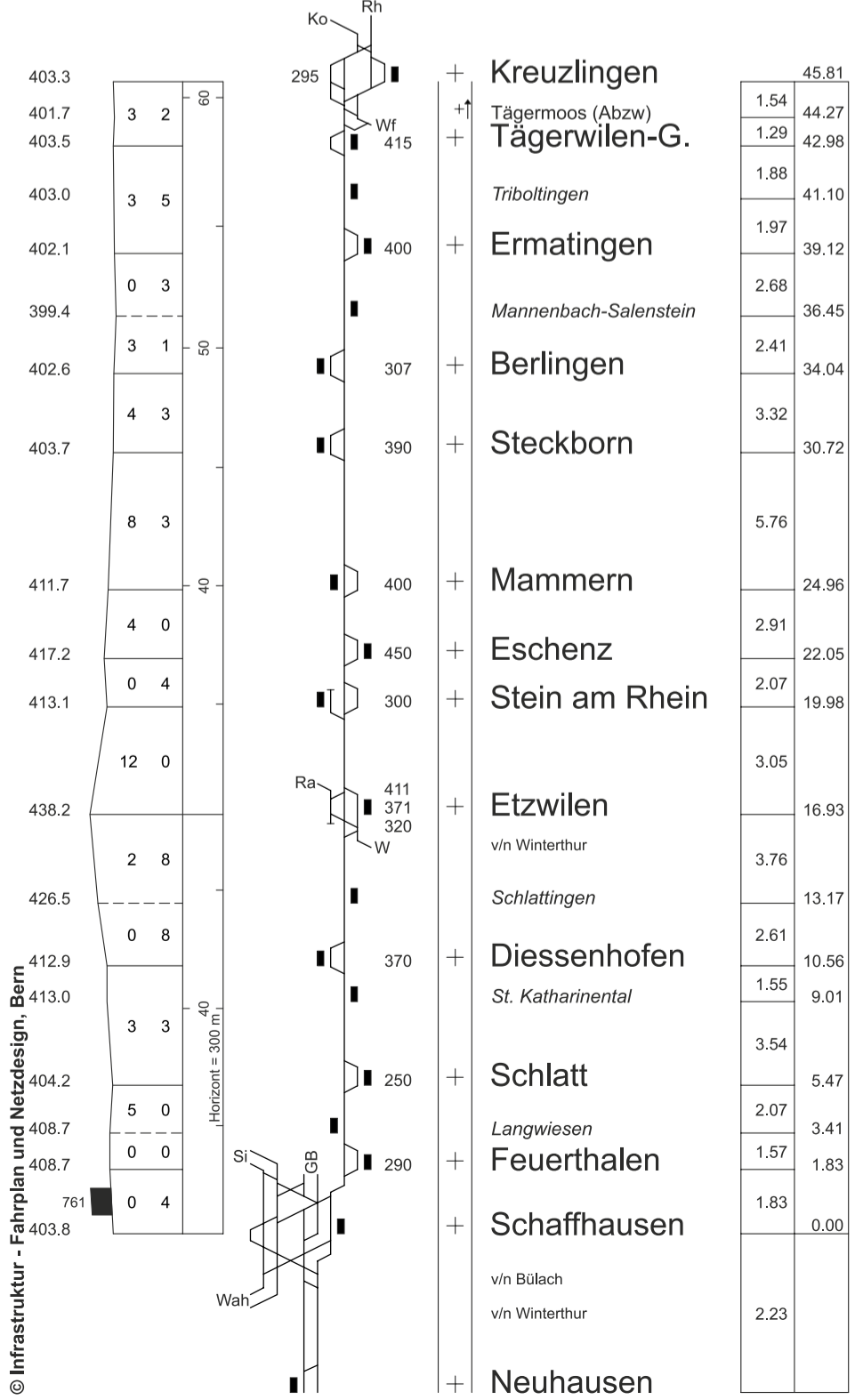
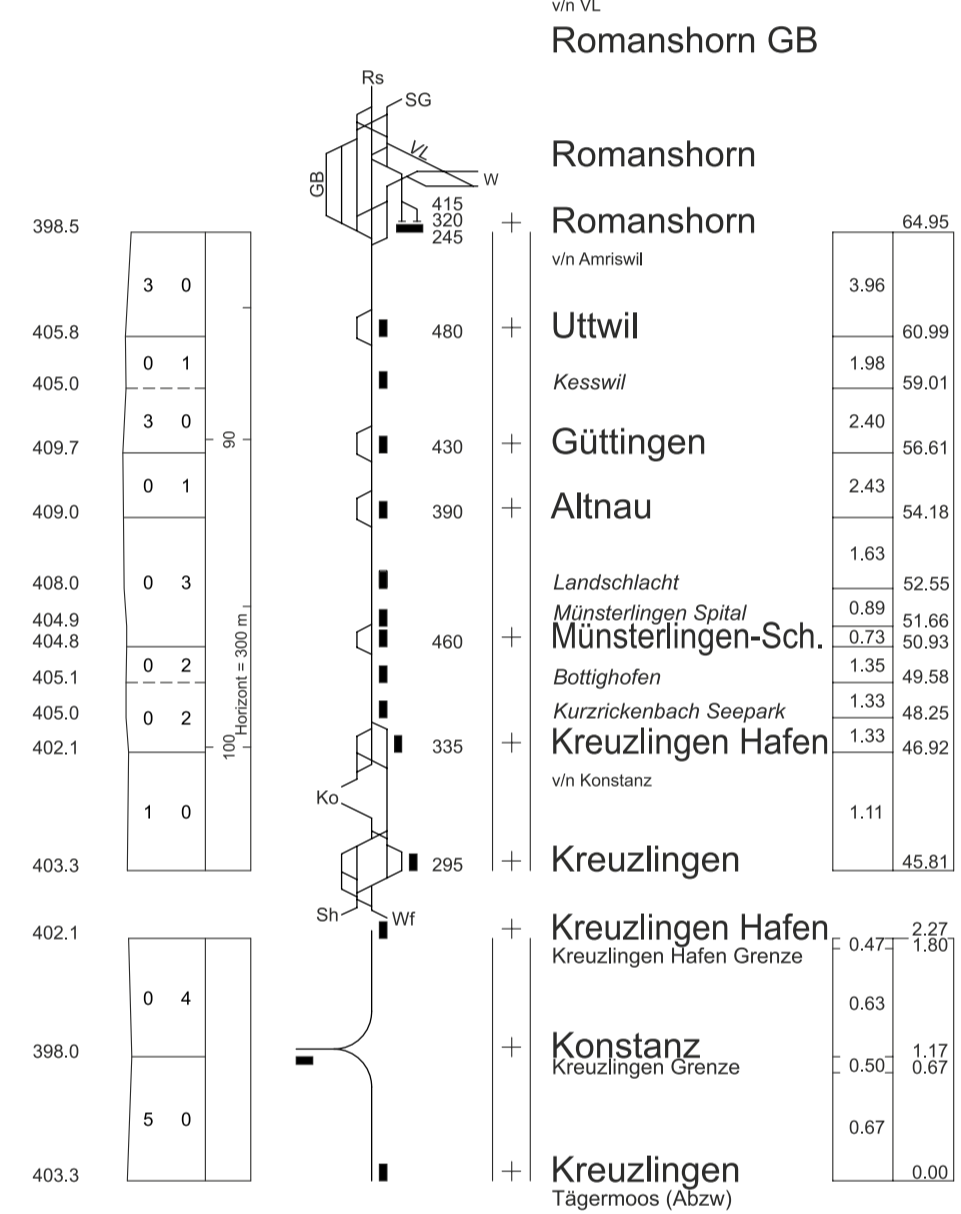
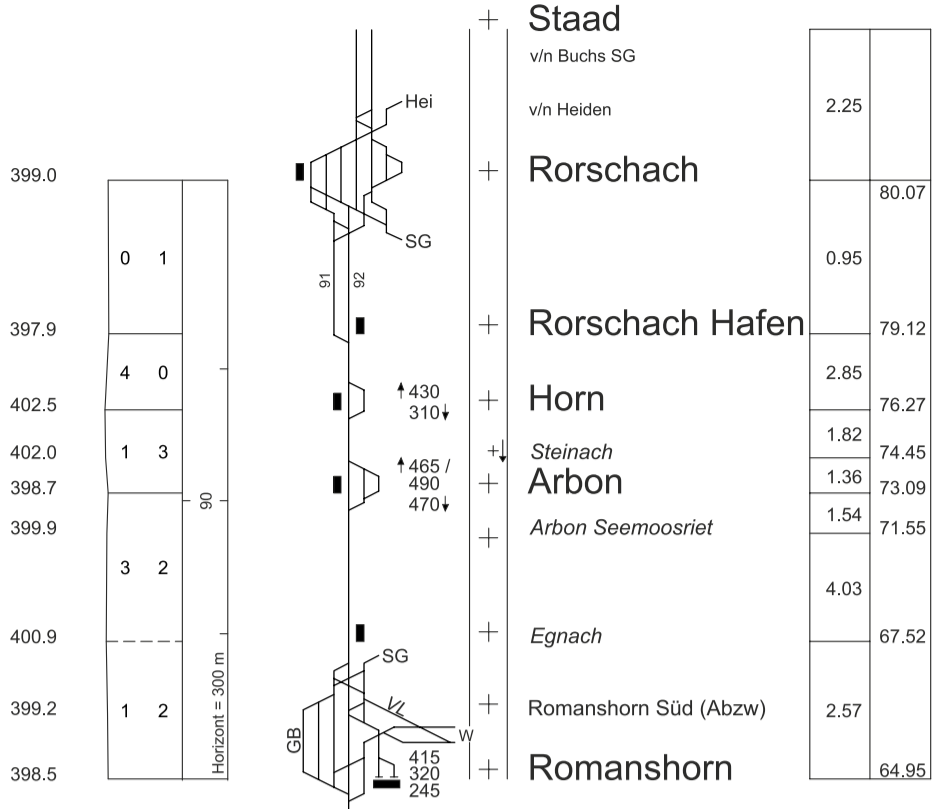

SOB SÜDOSTBAHN

79

15. Dez. 2013 - 13. Dez. 2014

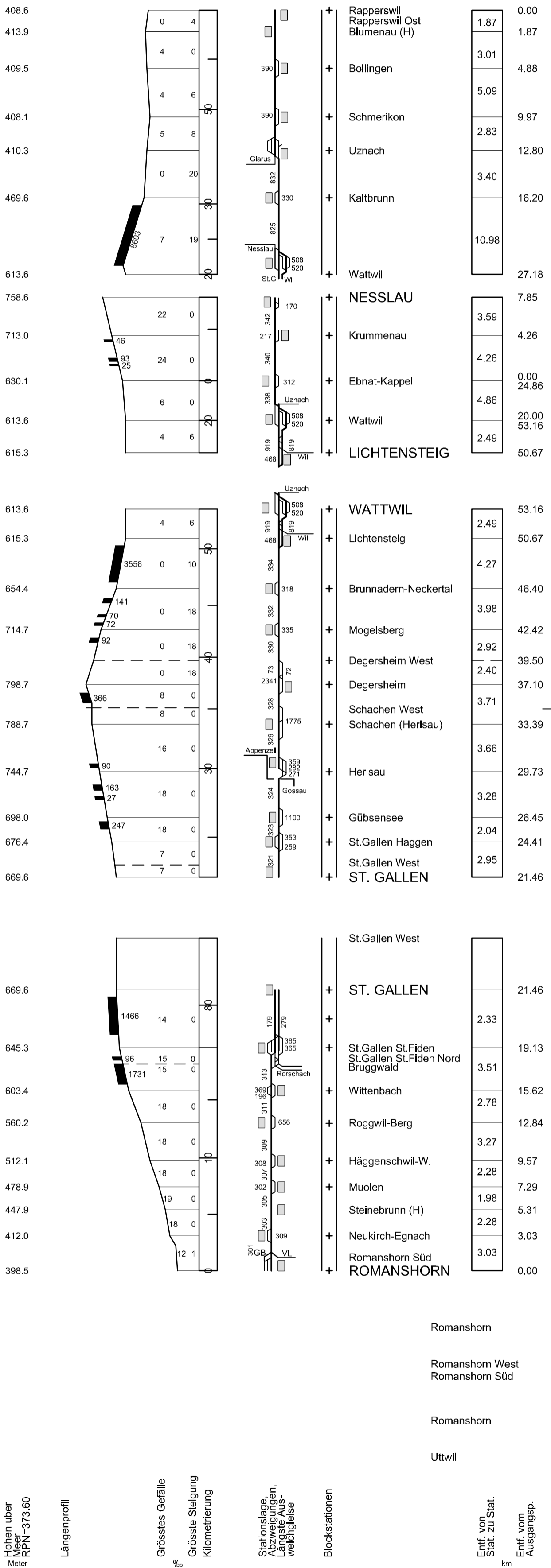

SOB SÜDOSTBAHN

78

15. Dez. 2013 - 13. Dez. 2014

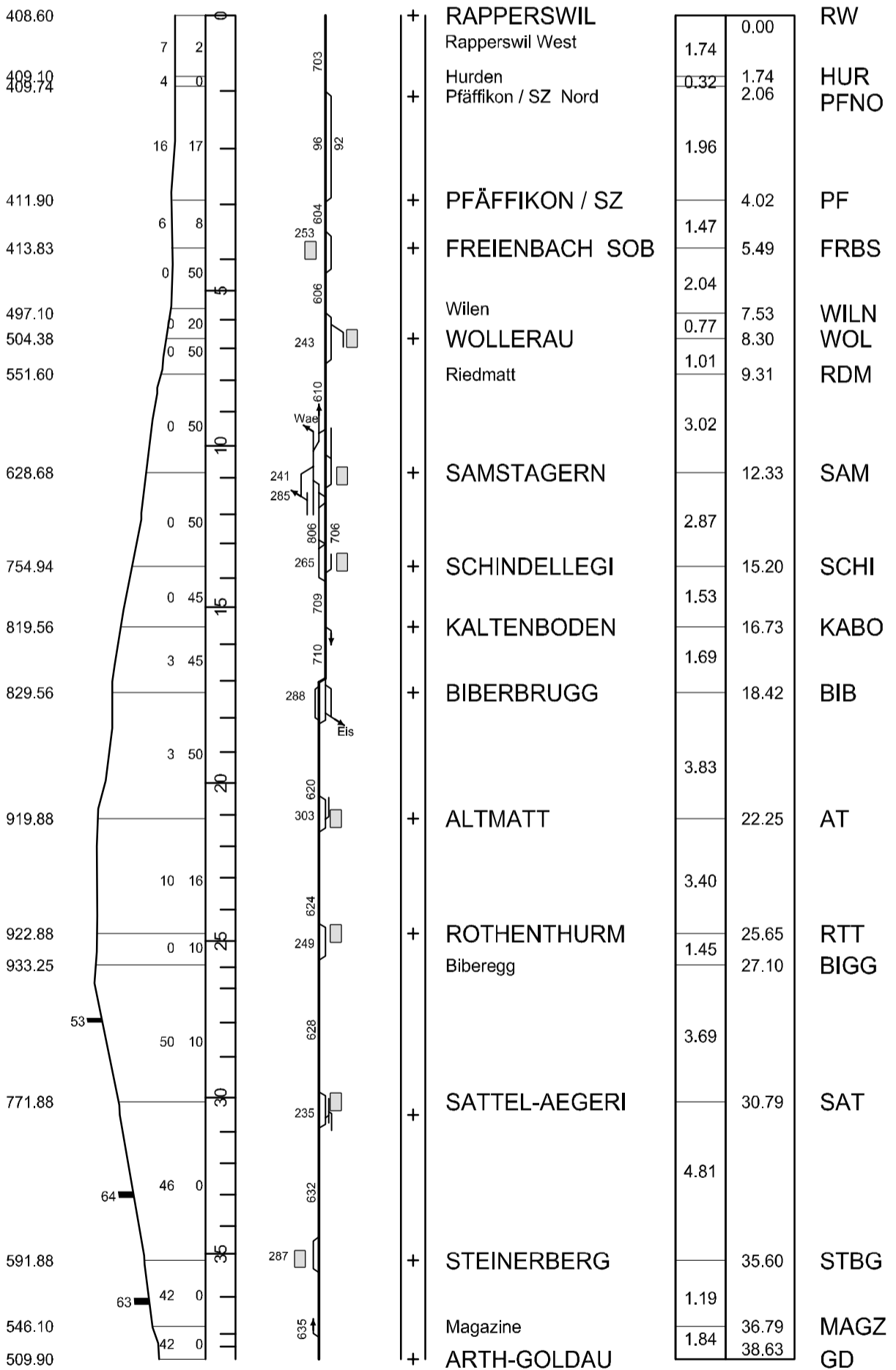
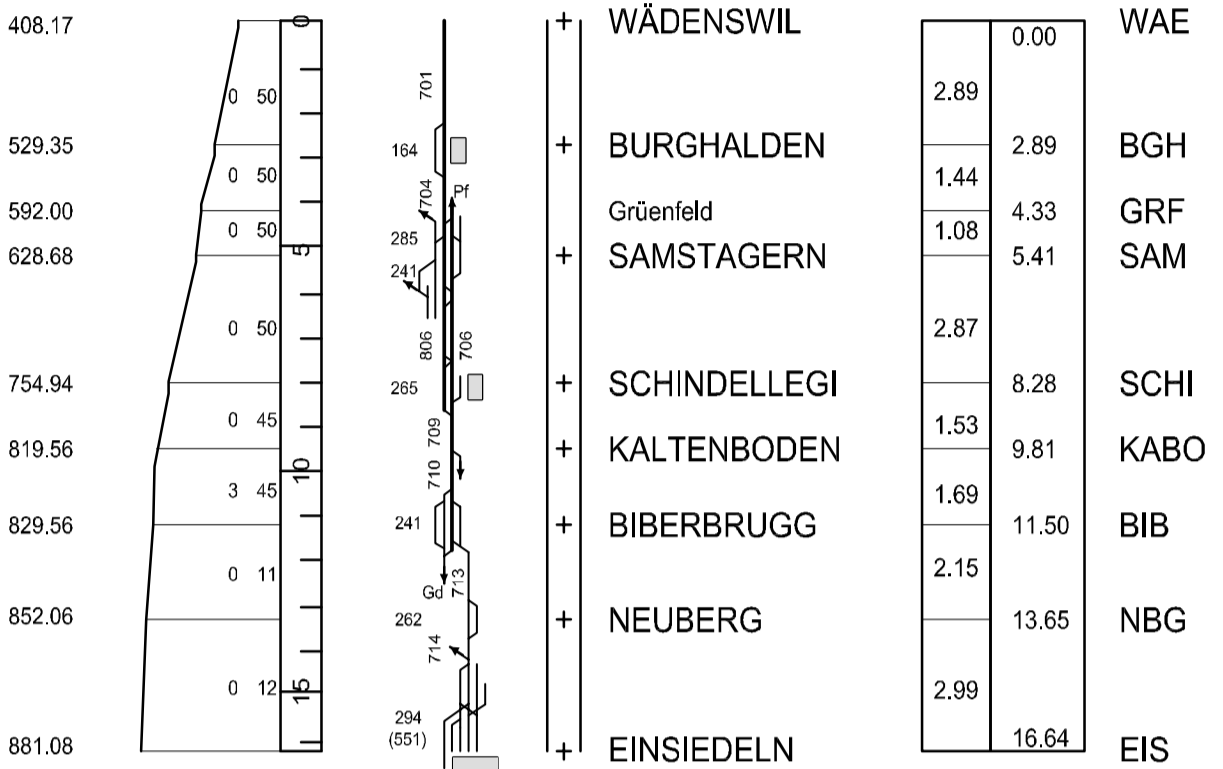

Höhen über Meer
RPN=373.60
Meter

Längenprofil

Grösstes Gefälle
Grösste Steigung
%

Kilometrierung

Stationslage,
Abzweigungen,
Längste Ausweichgleise
Streckengleisbezeichnung

Blockstationen

Entfernung zwischen
den Betriebspunkten
km

Entfernung vom
Ausgangspunkt